



State of Libya



Ministry of Education and Scientific Research

University of Sebha

Faculty of Energy and Mining Engineering

Department of Petroleum and Gas Engineering

& Department of Chemical Engineering

Entitled:

**Evaluation Filtration Properties of Water Based Drilling
Fluid By using Nanoparticles "Magnesium aluminates
Spinel" and "Barley Husk Ash"**

Student achievement :

1- Jaber Bashir Ali

2-Somaya Abdusalam Ehjaz

3- Mahdi Mohammed Mahdi

4-Samar Hamed Ebrahim

Under Supervisors :

Mr. Mohammed Ahmed Samba

Mrs. Mahgouba saleh Al Tayep

Academic year (2018-2019)

بسم الله الرحمن الرحيم

قال تعالى :

(يَرْفَعُ اللَّهُ الَّذِينَ آمَنُوا مِنْكُمْ وَأَلْزَمُوا صَدُوقًا وَجَاهًا)

سورة المجادلة الآية : (11)

كَطَاقٍ اللَّهُ الْعَظِيمِ

إهداء

نبدأ بحثتنا المتواضع بحمد لله و بشكره و له الفضل و الثناء بأن ألهمنا القدره على كتابة هذا البحث.

نهذي هذا العمل المتواضع:

- إلى منارة العلم والإمام المصطفى سيد الخلق رسولنا محمد صلى الله عليه وسلم
- إلى النور الذي ينيرون لنا دروب النجاح آبائنا
- إلى من ركع عطاء أمام قدميهن و أعطينا من روحن و عمرهن حبا و تصميميا و دفعا لغد أجمل
وعلمنا الصمود مهما تبدلت الظروف أمهاتنا
- إلى ملائكة الرحمن إلى الذين احتضنونا و زرعوا الورد و الضحكة في طريقنا .. إخواننا
- إلى رفاق الدرب بناء المستقبل أصدق و أروع البشر أصدقائنا
- إلى من أضاءوا بعلمهم عقول غيرهم أو أهدوا بالجواب الصحيح حيره سائلهم فأظهروا بسماحتهم
تواضع العلماء و برحابتهم العارفين (الأساتذة الأفاضل) و أخص بالذكر أستاذنا و مشرفنا على هذا
المشروع أ . محمد أحمد الشريف صمبه
- إلى هذا الصرح العلمي الفتي الجبار كلية هندسة الطاقة والتعدين – جامعة سبها
نقول لهم: أنتم وهبتمونا الحياة والأمل والنشأة على شغف الإطلاع والمعرفة لكم جميعا نهذي سهرنا
وتعبنا و جهدنا.
- و أرجو من الله عز وجل أن يجد القبول و النجاح و أن يوفقنا لما يحب و يرضى.

الشكر و التقدير

الحمد لله تعالى والصلاة والسلام على نبينا محمد - صلى الله عليه وعلى آله وصحبه أجمعين.

نتوجه بآيات الحمد و الشكر لله سبحانه و تعالى على ما وهبنا من الصبر و توثيق و تخطي كل ما صادفنا من صعاب في إنجاز هذا العمل.

كما تتسابق الكلمات و تتزاحم العبارات ، لتنظم عقد الشكر الذي تستحقه عائلتنا الذين كانوا الداعمين الأساسيين للوصول إلى هذه المرحلة .

إلى الأساتذتنا الذين يستحقوا منا كل التقدير و الإحترام ، وأخص بالشكر مشرف البحث / أ.محمد صمبه الذي أثبتت جدارته بتواجده و عطاءه الرائع و مجهوداته الجباره في تقديم البحوث العلمية.

ونشكر أ. محجوبه صالح الطيب لإشرافها على الجانب العملي لتحضير المسحوق النانوي ، و كما نشكر أ. مسعودة فرحات لتعاونها معنا في تحضير مادة رماد نخال الشعير .

و كما نود أن نعرب عن امتناننا لجامعة سبها ، و قسم الهندسة و البترول و القسم الهندسة الكيميائية من كلية الهندسة الطاقة و التعدين ، و قسم الكيمياء بكلية العلوم .

كما يسعدنا أن نتقدم بالشكر و التقدير إلى جميع الفنيين و الأساتذة في كلية العلوم ، الذين ساهموا أيضا بوقتهم و اهتمامهم و مهاراتهم المهنية لإستكمال هذا البحث .

ونتقدم بالشكر والتقدير أيضا إلى قسم هندسة البترول من كلية الهندسة في جامعه طرابلس

لاستضافتهم لنا وتقديم المساعدة و توجيهات لإجراء الاختبارات اللازمة على سائل الحفر في هذا البحث و خاصة أ. بشير التومي.

Table of Contents

Abstract.....	XIII
Introduction.....	1
Chapter 1: Petroleum Drilling Process.....	4
1.1 Petroleum Drilling Process.....	4
1.2 Drill a Well by Mechanical Stress.....	4
1.3 Rig Towers.....	5
1.4 Rig component and systems.....	5
1.4.1 Power System.....	5
1.4.2 Hoisting System.....	6
1.4.3 Rotating System.....	6
1.4.4 Mud Circulating System.....	8
1.4.5 Isolate System (Blow out Preventers (BOP)).....	9
1.5 Type of Drilling.....	9
1.6 Major Problems occur While Drilling operations.....	10
Chapter 2: Drilling Fluid.....	11
2.1 Introduction of Drilling Fluid.....	11
2.2 Importance of Drilling Fluid.....	11
2.3 Composition Drilling Fluid.....	12
2.4 Classification of Drilling Fluid.....	12
2.5 Function of Drilling Fluid.....	12
2.6 Mud Cake.....	13
2.7 Properties of Drilling Fluid.....	13
2.8 Relations between Composition & Properties of Drilling Fluid.....	14
2.10 Additives for Drilling Fluid.....	14
2.11 Apparatus used to Measure the Properties of Drilling Fluids.....	15

Chapter 3: Study the Problem of Loss Drilling Fluid.	18
3.1 The Problem.....	18
3.2 Causes of Loss of Drilling Fluid.....	18
3.3 Classification of Drilling Fluid Loss.....	19
3.4 What Are The Side Effect of Drilling Fluid Loss.....	19
3.5 The Methods of Treatment Loss of Drilling Fluid.....	19
3.6 Methodology of the Study.	20
Chapter 4 : Preparation of Barley Husk ahs	21
"The Theoretical Side"	21
4.1 Introduction.....	21
4.2 Chemical Composition of BHA.....	22
"Practical side"	23
4.3 Preparation of Barley Husks Ash (BHA).....	23
Chapter 5: Preparation Nanoparticles " Magnesium aluminate Spinel" (MAS)	25
"The Theoretical Side"	25
5.1 Introduction.....	25
5.2 Magnesium aluminate Spinel (MAS)	26
5.3 Physical and Chemical Properties of Magnesium Aluminate Spinel(MAS).....	26
5.4 Applications of Magnesium Aluminate Spinal (MAS)	26
5.5 Methods of Preparing Nanoparticles "Magnesium Aluminate Spinal" (MAS).....	27
5.6 Analytical Instruments.	27
5.7 Potential impurities that appearing With Magnesium aluminate Spinel.	28
"Practical side"	29
5.8 Laboratory Safety Instructions and Recommendations.	29
5.9 Sol-gel Method.....	29
5.10 Materials.	29
5.11 Calculations To Prepare 30 g of $MgAl_2O_4$	29

5.12 Tools experiment.	30
5.13 Steps of the experiment.....	30
5.14 Analysis and Results	35
1. FT-IR analysis.....	35
2. XRD analysis.	36
5.15 Calculations.....	38
1. Crystalline Size D	38
2. Unit cell Volume (V _{cell}).	39
3. The X-ray density (ρ_{XRD})	39
Chapter 6 : Filtration Test	40
6.1 Introduction.....	40
6.2 Filtration.....	40
6.3 Types of Filtration.	41
6.4 Installing of Filter Press.	41
"Practical side"	42
6.5 Laboratory Safety Instructions and Recommendations.	42
6.6 Preparation of drilling fluids.....	42
6.7 Test Procedures.....	43
6.8 Results and Calculations.....	44
6.10 Additional Tests Procedures.	47
1. Mud density test Procedures.	47
2. Mud Rheology Test Procedures.....	51
2.1 Mud Viscosity Test Procedures	51
2.2 Gel Strength Test Procedure.	51
2.3 Yield Point Measurement.	51
2.4 Result and Calculations.....	52
Discussion_.....	58

Conclusion	58
Appendixces.....	60
References.....	62
Bibliography	65

List of Figure

Fig 1 : Types of Drilling.....	10
Fig 2 : Mud Balance	17
Fig 3 : Viscometer Apparatus.....	18
Fig 4 : Filter Press Apparatus	18
Fig 5 : Ph Dispensers And Ph Meter	19
Fig 6 : Drying of Barley Husk in Sunny Place.....	25
Fig 8 : Burning Furnace.....	26
Fig 9 : Screening of Barley Husk Ash.....	26
Fig 10 : Weight of $\text{Al}(\text{OH})_3 \cdot \text{XH}_2\text{O}$	32
Fig 11 : Weight of $\text{MgCl}_2 \cdot 6 \text{H}_2\text{O}$	33
Fig 13 : Suspende of $\text{MgCl}_2 \cdot 6 \text{H}_2\text{O}$	34
Fig 14 : Addition Aluminum Hydroxide Solution From A Separating Funnel To Magnesium Chloride Solution.....	34
Fig 15 : Filtration By Buchner Funnel.	35
Fig 16 : drying of $\text{Mg Al}_2 \text{O}_4$	35
Fig 17 : Burning Furnace.....	36
Fig 18 : FT-IR spectra of $\text{Al}(\text{OH})_2 \cdot \text{XH}_2\text{O}$	37
Fig 19 : FT-IR spectra of $\text{MgCl}_2 \cdot 6\text{H}_2\text{O}$	37
Fig 20 : FT-IR spectra of $\text{Mg Al}_2 \text{O}_4$	38
Fig 21 : XRD analysis of $\text{Mg Al}_2 \text{O}_4$	38
Fig 22 : Standard API Filter Press	45
Fig 23 : Filtration Test of Fresh Mud + 3g for different Materials	47
Fig 24 : Filtration Test of Fresh Mud + 5g for different Materials	48
Fig 25 : Filtration Test of Fresh Mud + 7g for different Materials	49
Fig 26 : Density Test of Fresh Mud + 3g for different Materials.....	52

Fig 27 : Density Test of Fresh Mud + 5g for different Materials.....	53
Fig 28 : Density Test of Fresh Mud + 7g for different Materials.....	54
Fig 29 : Rheology Test of Fresh Mud + 3g for different Materials.....	56
Fig 30 : Rheology Test of Fresh Mud + 5g for different Materials.....	57
Fig 31 : Rheology Test of Fresh Mud + 7g for different Materials.....	58

List of Table

Table 1 : The Classifications of Rig Towers.....	17
Table 2 : Some Compounds Formula of BHA.....	36
Table 3 : Characteristics of MAS.....	40
Table 4 : Results of XRD Analysis Into $Mg Al_2 O_4$	51
Table 5 : Calculation For Find Crystalline Size D.....	52
Table 6 : Calculation For Find Length of Cubic	53
Table 7 : Results of Filtration Test For Mud+3g Materials.	47
Table 8 : Results of Filtration Test For Mud+5g Materials	48
Table 9 : Results of Filtration Test For Mud+7g Materials	49
Table10 : Results of Density Test of Fresh Mud +3g Materials.....	52
Table11 : Results of Density Test of Fresh Mud +5g Materials.....	53
Table12 : Results of Density Test of Fresh Mud +7g Materials.....	54
Table13 : Results of Rheology Test of Fresh Mud +3g Materials.....	56
Table14 : Results of Rheology Test of Fresh Mud +5g Materials.....	57
Table15 : Results of Rheology Test of Fresh Mud +7g Materials.....	58

List of Nomenclatures

1. Shortcut Words.

Symbol	Words
DF	Drilling Fluid
WBM	Water Based Mud
OBM	Oil Based Mud
BOP	Blow out Preventers
API	American Petroleum Institute
MAS	Magnesium aluminate Spinel
BHA	Barely Husk ash
CMC	nanocarboxymethyl cellulose
SOL-GEL	Solution - Gel
XRD	X-ray Diffraction
IR	Infrared

2. Molecular Formula.

Molecular Formula	Chemical Compounds
$MgAl_2O_4$	Magnesium aluminate Spinel
$Al(OH)_3 \cdot xH_2O$	Aluminum hydroxide
$MgCl_2 \cdot 6H_2O$	Magnesium Chloride hexa hydrate
MgO	Magnesium Oxide
Al_2O_3	Aluminum Oxide
SiO_2	Silica dioxide
K_2O	Potassium Oxide
CaO	Calcium Oxide
Fe_2O_3	Ferrous trioxide

3. Unites.

Symbol	Name
rpm	Rotates per minute
min	minute
C°	Celsius
A°	Angstrom
in	inch
m	meter
cm	centimeter
mm	millimeter
nm	nanometer
g	gram
ml	milliliter
ppg	Pound per gallon

Abstract

In this project , the problem of loss of drilling fluid was studied , and the water-based drilling fluid test was also conducted to improve in filtration properties by using nanoparticles " magnesium aluminates spinel " and " barley husk ash" and evaluate the results obtained and compare them with previous study that has improved in filtration properties of water based drilling fluid by using nanocarboxymethyl cellulose , it is among recent studies that have been successful and have been applied.

In addition, barley husk ash and magnesium aluminates spinel was chemically prepared by Sol-Gel , and conducting analysis (FT-IR , XRD) for magnesium aluminates spinel of reactants (Aluminum hydroxide , Magnesium Chloride hexa hydrate) , and to compare them with the standard analysis of these materials to be sure of purity and storage method , and has also been conducting these analysis of the production materials to ensure the composition of the material and function groups by analysis (FT-IR) and crystalline structure by analysis (XRD) , and engineering calculations (Crystalline size , length of the cube side , density of through XRD , surface area of through XRD) , the filtration properties of the drilling fluid were then tested by filter press equipment , additional tests were conducted for other properties of the drilling fluid , including (density , viscosity , gel strength , pH , yield point) , the results obtained were evaluated and compared with result when using nanocarboxymethyl cellulose .

Key words: Drilling fluid loss , Magnesium aluminate spinel , barley husk ash.

Introduction

Drilling fluids are the key to the success of the drilling process so that it has many functions in drilling operations, and almost all problems encountered in drilling operations are directly or indirectly related to drilling fluid properties.[1-3]

Drilling by drilling fluids in layers is one of the most expensive problems when drilling wells because of the large quantities of drilling fluid leakage before solving the problem and the time spent digging to solve the problem, Therefore the quality and properties of the drilling fluid must be matched with drilling conditions to achieve the best performance, optimum selection of drilling fluid is a key factor in minimizing drilling time and cost .[4, 5]

The drilling fluid was used as water based drilling fluid is more referable and attractive option than oil and synthetic fluids for drilling oil and gas wells in sensitive areas where oil base fluids are not desired. envelopment of high performance and more environmental friendly water base fluids are desirable .[5]

Water-based drilling fluid mainly consists of water as base fluid, inert and reactive solids as additives which still has many disadvantages including shale instability, formation damage, poor cake properties and high fluid loss; recently, nanowater-based fluid has been proposed by several researchers for overcoming related issues in drilling fluid such as controlling fluid loss, minimizing formation damage, improving wellbore stability and subsequently improving drilling performance. Due to high surface to volume ratio of nanosized particles, they can change chemical and physical properties of drilling fluids.[6-11]

The number of studies proved successful results to improve the characteristics of the drilling fluid, which improved its performance during the drilling process, which reduced the problems that increase the cost and avoid drilling

in the non-productive time , In the year 2017, Rahmatallah Saboori , Samad Sabbaghi , Azim Kalantariasl , Dariush Mowla1 studied Improvement in filtration properties of water-based drilling fluid by nanocarboxymethyl cellulose/polystyrene core–shell nanocomposite (CMC) , The results of this study were successful in improving the filtration properties. Based on this study, CMC is currently used in the process Drill to improve from this property.[12]

But the material CMC used in this study is very expensive when purchased for use in drilling fluids in large quantities, Causing the cost of drilling to increase. Therefore, We conducted this study to avoid the lost time to address the problem of loss of drilling fluid through the clay cake to the ground formation ,Using less expensive materials to produce successful filtration properties while preserving the rest of the drilling fluid in the acceptable range, So that these materials are equivalent to the work of the CMC material in the drilling fluid during the drilling process.

The materials used in this project are:

1 –Magnesium alumina Spinel (MAS).

This material was used on the basis of scientific studies conducted on these materials in terms of composition and physical and chemical properties. Which showed in their results that they bear high temperature, high melting point, mechanical strength and high chemical resistance.[13, 14]

Which showed that this material bore the conditions of the drilling fluids during the drilling process.

2- The Barley Husk ash (BHA).

This material has been used for several studies which proved that it has good properties, including its ability to close the porosity of the layer, and through this study we find that it can close the porosity of the ground formation during the drilling process, which reduces the loss of drilling fluid during drilling.[15]

A methodology was put for this study, which is described in the chapter (3)
So that the scientific writing of this project, composed of the following chapters:

Chapter 1: Petroleum Drilling Process.

Chapter 2: Drilling Fluid.

Chapter 3: Study the Problem of Loss Drilling Fluid.

Chapter 4: Preparation of Barley Husk ash (BHA).

Chapter 5: Preparation Nanoparticles "Magnesium Aluminate Spinel" (MAS)

Chapter 6: Filtration Test.

We offer this work and hope it will be beneficial to all our students and employees in the fields of oil and gas, serving our oil and gas industry to grow.

Chapter 1: Petroleum Drilling Process.

1.1 Petroleum Drilling Process.

The petroleum is organic material derived from plants and animals which grew in abundance , As these organisms went through their cycles of growing and dying , buried Over millions of years , organic material slowly decayed and became our present-day oil, gas, coal .

Oil, gas and water slowly migrate through permeable rocks, driven by natural forces of gravity and pressure gradients , then migrated further into traps that we now call reservoirs.

There are many methods have been used to locate petroleum traps , after it has been established that a petroleum reservoir probably exists , and Access to oil is done through drilling by mechanical stress which are internationally recognized.[16]

The term drilling indicates the whole complex of operations necessary to construct wells applying excavation techniques.

Drilling of well is a hole or passage (a cylindrical hole) that is often vertical, drilled in the ground through rocks to extract groundwater, oil or gas, from the ground to the surface, with suitable diameter and depth.[17]

Generally petroleum Drilling process Is dill a hole with a certain depth in as little time as possible for the production of oil and gas .

1.2 Drill a Well by Mechanical Stress.

Oil wells are drilled in basic steps:

- 1.** Surface location.
- 2.** Lithology column.
- 3.** Rig mobilization.
- 4.** Spud the well.

5. Start drilling.

For the beginning of the drilling process, to begin the drilling process you must first know the rig equipment and components.

1.3 Rig Towers

Drilling towers drill holes in the ground, Drilling is carried out on land and water, Drilling towers are classified according to depth, shape, and power source used in the drilling process for these towers. The classification is shown in the following table:

Table 1: The Classifications of Rig Towers[18]

Hors Powder	Shapes	Power Source
Light Wt. Rig	Land rig	Mechanical rig
Intermediate Rig	Jackup rig	Diesel electric rig
Heavy Wt. Rig	Platform	Electric rigs
Ultra-Heavy Rig	Submersible	//
//	Semisubmersibles	//
//	Drill ship	//

1.4 Rig Component and Systems.

1. Power system.
2. Hoisting system.
3. Rotating system.
4. Circulating mud system.
5. Isolate System.[18]

1.4.1 Power System.

Land rigs are classified by the source of power . there are three classifications of rigs:

1. Mechanical rig: The power to operate everything on a mechanical or power rig.

2. Diesel electric rig: Uses diesel engines to turn large generators and most large rigs are diesel electric rigs.

3. Electric rigs: They can only operate in locations with a readily available supply of electricity.[18]

1.4.2 Hoisting System.

Hoisting system consists of:

1. Drawworks.

The principal function is to convert the power source into a hoisting operation and provide braking capacity to stop and sustain the weights imposed when lowering or raising the drill string.

2. Drilling Line.

3. Blocks.

The block and tackle which is rigged with the crown block by multiples of drilling line strung between the crown block and the traveling block.

4. Hook.

The hook is located beneath the traveling block, this device is used to pick up and secure the swivel and Kelly.

5. Derrick or Mast

Vertical structure that allows vertical clearance and strength to raise and lower the drill string .[18]

oil and gas are drilling in the rotary method , Drilling takes place when the drillstring and bit are rotated while the weight of the drill collars and bit more heavy on the rock.[18] .

1.4.3 Rotating System.

Rotating system is composed from:

❖ Top Drive

1. Rotary Table

Transmits the rotary motion or torque from the power source to the drive bushing.

2. Master Bushing.

The bushing that fits inside of the rotary table opening, this is where the drill pipe and collar slips seat when the drill string is suspended from the rotary table for connections or tripping pipe.

3. Kelly Bushing (Drive Bushing).

That bushing which fits inside the rotary bushing and transmits rotary torque to the Kelly.

4. Kelly.

The square or hexagonal member at the upper most part of the drill string that passes through a properly fitting bushing know as the Kelly bushing transmits rotary motion to the Kelly which results in the turning of the drill string .[18]

❖ Drill String.

5. Drill Pipe.

the main function of drill pipe is to transmit rotary motion under high pressure to the drill bit.[19]

6. Drill Collar.

Drill collars are used to provide weight on bit and to keep drill pipe in tension .[19]

7. Drill Bits

The drill bit represents the heart of the drill string, The drill bit crushes the rock under the combined action of weight on bit and rotary speed . The resulting chippings are flushed away by the circulating fluid, to allow the bit to attack a new surface of rock. The process of cutting the rock and flushing the drill cuttings results in a drill hole. [19]

There are two main types of bit types:

1. Roller cone (Rock Bit).

As the name implies, a roller cone bit employs cones which rotate about their own axis or about the bit axis and are suitable for soft formations, while insert-type bits can drill medium to hard formations.[19]

2. Fixed cutter (Fixed Head).

Fixed-cutter bits with diamond cutting surfaces are used for drilling medium to hard formations ,when extra-long bit life is needed or for special coring operations.[20]

1.4.4 Mud Circulating System.

1. Drilling fluid.

Generally speaking, Is the fluid used in the process of drilling oil wells, which is the suspension of solids in the fluid phase, so that the fluid phase is known as the base of drilling fluid and solids are the clay (bentonite) and solid materials that are added to improve the properties of drilling fluids .[19]

2. Circulating equipment.

The drilling fluid is pumped from the drilling fluid tank through pumps to the well hole through a hole shaft. The mud returns to the surface through the annulus of the borehole drilling fluid is cleaned from impurities in several stages And then pump it back to the well. The stages through which the drilling fluid is cleaned are:

2.1Shale shaker.

It is a basin that separates the large impurities from the drilling fluid by the shale shake.

2.2 Desander.

Is a device that works to remove sand from the drilling fluid .

2.3 Desilter.

Is a device that works to remove very fine particles from the drilling fluid.

2.4 Degaser.

The equipment used to remove unwanted gas from drilling fluid Mud-Gas Separator a device that remove gas from the mud coming out of a well when a kick is being circulated out.

2.5 Tank.

It is a tank made of steel plates and contains drilling fluid, through which the drilling fluid is recycled.

2.6 Pump.

A large pump used to circulate mud on a drilling rig.

1.4.5 Isolate System (Blow out Preventers (BOP))

This system is used in case unwanted fluids flow from formation to the well which may develop into a blowout if not controlled , It is done Blowout preventers in several stages are :

1. Hydrill (Annular Preventers) .
2. Pipe Rams.
3. Blind Rams.
4. Shear Rams.[19]

1.5 Type of Drilling.

1. Conventional Drilling.

This type of drilling is done vertically on the surface directly, since this type of drilling is traditional and is still common today.

2. Horizontal Drilling.

Where this type is fairly horizontal in parallel to the surface.

3. Directional Drilling.

This type of drilling is done by controlling the direction of the drilling at a specified angle and the direction and depth can be changed several times in the well.[21]



Fig 1: Types of Drilling[22]

In this case you must collect sufficient information and understanding in a good way for this kind of problems and this is highly dependent on the human element.[23]

1.7 Major Problems occur While Drilling operations.

Problems that may be encountered by drillers can be divided into three categories although almost always they would be interactive :

1. Drilling problems.
2. Hole problems.
3. Mud problems.[23]

The title of our research falls under the mud problems .

Chapter 2: Drilling Fluid.

2.1 Introduction of Drilling Fluid.

The objective of a drilling operation is to drill, evaluate and complete a well that will produce oil and/or gas efficiently.

Drilling fluids perform numerous functions that help make this possible. The responsibility for performing these functions is held jointly by the mud engineer and those who direct the drilling operation. The chief duty of the mud engineer is to assure that mud properties are correct for the specific drilling environment. The mud engineer should also recommend drilling practice changes that will help reach the drilling objectives.[20]

2.2 Importance of Drilling Fluid.

Drilling fluid or drilling mud is a critical component in the rotary drilling process. Since it is such an integral part of the drilling process , The drilling fluid is similar to the blood of the well, as an expression of its importance and role in the manufacture of drilling oil and gas wells, and has been similar to the same role and functions performed by the blood for any organism.

A well cannot be completed, no matter what the planned final depth is, and the ultimate goal of drilling without using this liquid.

And by examining the properties of the drilling fluid from the well, we can infer the function of the well and the operation of the drilling, we can monitor the flow of the well hole by observing the drilling fluid.

A change in the properties of drilling fluid from the well will be followed by a change in the position of the well and how the drilling will proceed .[24]

2.3 Composition Drilling Fluid.

Drilling fluids generally consist of:

1. Base material: It is the fluid that forms the basic part of the drilling fluid (water – oil – air).
2. Solid phase: which can be effective or idle (clay).
3. Additives: These additives chemicals .[25]

2.4 Classification of Drilling Fluid.

There is no specific standard for the classification of drilling fluids, but the most widely used classification is based on the base material:

1. Water-Base Muds (WBM).

This group includes all drilling fluids, which is the base material which is water and include several groups:

- 1.1 Fresh Water

- 1.2 Salt Water.

2. Oil-Base Muds (OBM).

This group includes all the drilling fluids that make up oil or any of its derivatives. The water and other materials are scattered in the oil , Such as Emulsified drilling fluids.

3. Gas (Air).

It is used to penetrate the cohesive layers, which do not contain fluids under pressure in their pores .[24]

2.5 Function of Drilling Fluid.

The main functions of the drilling fluid during the drilling process are:

1. Remove Cuttings From The Well.

For effective drilling, cuttings generated by the bit must be removed immediately. The drilling mud carries these cuttings up the hole and to the surface, to be separated from the mud. and to be recirculated.

2. Rotate of The Drill Bit.

The drilling fluid helps turn the drill head of the bit by pumping the drilling fluid so that it increases the rotation of the bit.

3. Cooling and Lubrication the Drill Bit.

One of the prime functions of mud is to cool the drill bit and lubricate its teeth. The drilling action requires a considerable amount of rotation and hydraulic energy.

A large proportion of this energy is dissipated as heat, which must be removed to allow the drill bit to function properly .[19]

4. Control Formation Pressure.

For safe drilling, high-formation pressures must be contained within the hole to prevent damage to equipment and injury to drilling personnel. The drilling mud achieves this by providing a hydrostatic pressure just greater than the formation pressure. For effective drilling, the difference between the hydrostatic and formation pressures should be zero .[19]

2.6 Mud Cake.

Is the layer of drilling fluid that is formed on the wall of the well to maintain the shape of the well.

2.7 Properties of Drilling Fluid.

The properties that are of great importance to the drilling fluid are:

1. Weight of Drilling Fluid.

Drilling fluid weight or, more precisely, drilling fluid density is defined as the mass of a given sample of mud divided by its volume. Mud weight is dependent largely upon the quantity of solids in the liquid phase, either in solution or suspended by the particles of the liquid phase.[19]

2. Viscosity.

Viscosity is a property which controls the magnitude of shear stress which develops as one layer of fluid slides over another. [19]

3. Gel strength.

Gel strength is a measure of the ability of mud to develop and retain a gel structure. It is analogous to shear strength, and defines the ability of mud to hold solids in suspension. It also gives an indication of the thixotropic properties of mud. [19]

4. Filtration.

When a drilling mud comes into contact with porous rock, the rock acts as a screen allowing the fluid and small solids to pass through, retaining the larger solids. The fluid lost to the rock is described as 'filter' The layer of solids deposited on the rock surface is described as 'filter cake ', filtration occurs only when there is a positive differential pressure in the direction of the rock.[19]

2.8 Relations between Composition & Properties of Drilling Fluid.

In order to effectively control the properties of a mud, we need to know how specific changes in mud composition will affect the properties. There are normally a number of ways that a mud property can be adjusted to a given value. However, we are usually faced with maintaining several properties within acceptable limits.

This means that there is one best way to adjust a mud property and still maintain control of the other properties. In order to accomplish this, we must understand the interrelationship between mud composition and mud properties.

The liquid and solids content of a mud form the foundation which ultimately determines the performance of the mud. Chemical treatment should be thought of as a means of making small or selective adjustments in mud properties and not as the primary controlling component of a mud.[26]

2.10 Additives for Drilling Fluid.

Any additive to the drilling fluid to achieve certain properties the most common materials added to clay such as:

1. Barite: to increase the weight (Density).
2. Bentonite: to increase the viscosity.
3. CMC: to decrease the drilling fluid loss.
4. Water addition: When the clay is thick due to accumulation of solids during drilling.
5. Chemically Treat: Chemically treated for bacterial control, lubrication and corrosion control, each additive has a function and is added according to the conditions of the hole.

And other materials that are added to improve the properties of the drilling fluid.

2.11 Apparatus used to Measure the Properties of Drilling Fluids.

There are several apparatus for measuring the properties of drilling fluids:

1. Mud Balance.

It is an apparatus used to determine the weight of drilling fluid (the density). This is done by dividing the weight on the volume, This apparatus is also used to know the gravity of the drilling fluid.

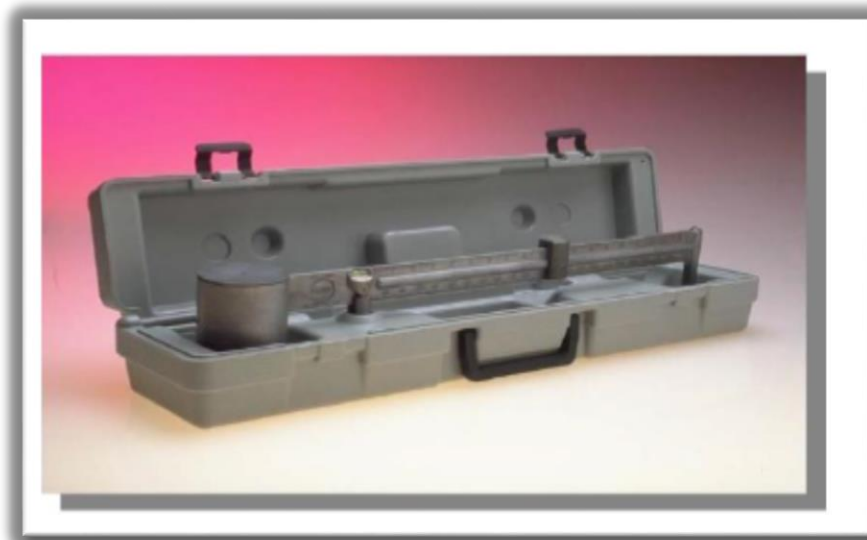

Fig 2 : Mud Balance [27]

2. Viscometer.

Is a apparatus used to determine the viscosity of the drilling fluid, and this is done at different speeds.

- ❖ Low speeds (300, 3, 100) rpm
- ❖ High speeds (600, 6, 200) rpm

The gel strength for the drilling fluid is determined in constant conditions (no flow) for 10 seconds and 10 minutes, and is also a measure of the particle forces determined by the yield point in mechanical conditions.



Fig 3: Viscometer apparatus[27]

3. Filter Press.

Is an apparatus used to calculate the amount of water lost from the drilling fluid through the mud cake layer by filtration depending on the pressure and within a period of time not exceeding 30 minutes, and also know the thickness of mud cake to the drilling fluid.



Fig 4: Filter Press apparatus[27]

4. pH Dispensers and pH Meter.

It is through which know the concentration of the hydrogen ion that is obtained in the results to know the drilling fluid if it is acidic or base.



Fig 5: pH Dispensers and pH meter[27]

Chapter 3: Study the Problem of Loss Drilling Fluid.

3.1 The Problem.

The leakage of the drilling fluid by definition is a partial or total loss of drilling fluid in cracks, pores and natural voids in the layer, a common problem in drilling oil wells.

Which causes a great loss of time and a high cost increase, and the degree of seriousness of this problem is due to the degree of smuggling, which ranges from a small amount is difficult to observe the total leakage and loss of circulation, and can be observed leakage by monitoring the level of liquid in the reservoirs working and pressure.

The level of fluid in the tanks is slowly decreasing due to the loss of the filter from the drilling fluid and the absorption of water by the walls. Therefore, the leakage rate is difficult to determine, and when it reaches a rate it can only be observed through a significant decrease in the level of liquid in the reservoirs. That the development of drilling techniques led to the operation of electronic devices can detect the leak and determine the quantities accurately.[24]

3.2 Causes of Loss of Drilling Fluid.

Divided into two groups:

1. Natural and related to the characteristics of the layers in terms of contain cracks and natural channels as well as large dimensions, and these causes cannot be avoided, but the choice of drilling fluid and the method of drilling depending on it.
2. A process that makes pressure inside the well greater than class pressure.[24]

3.3 Classification of Drilling Fluid Loss.

1. Simple loss: It disappears with time by closing the channels of the layer material carried by the drilling fluid.
2. Partial loss: The volume of drilling fluid out of the well is less than the volume inside it.
3. Total loss: where the full-size pump goes from the drilling fluid into the layers.
4. Severe loss: Is where the loss of fluid is severe. [24]

3.4 What Are The Side Effect of Drilling Fluid Loss.

The phenomenon of smuggling of drilling fluids in the layers is one of the most expensive problems when drilling wells, because of the large quantities of leaks of drilling fluids before the problem can be solved, and the time it takes to solve this problem, which leads to longer drilling time and thus increase the cost of drilling, in addition to the significant negative effects of this problem on the specifications of the layers and on wall and the continuation of the drilling process.[24]

3.5 The Methods of Treatment Loss of Drilling Fluid.

Infusion is treated according to its type or severity:

1. Reduce the pumping pressure of the pump.
2. Close the leaching area using different injection mixtures.
3. Change the drill path.
4. Add materials to the drilling fluid.[24]

The method used in this research is included under the method of treatment of loss of drilling fluid by adding materials to the drilling fluid, and the reason for choosing this method of treatment because it is a way of economic to try to solve this problem, which gives great success in the results.

3.6 Methodology of the Study.

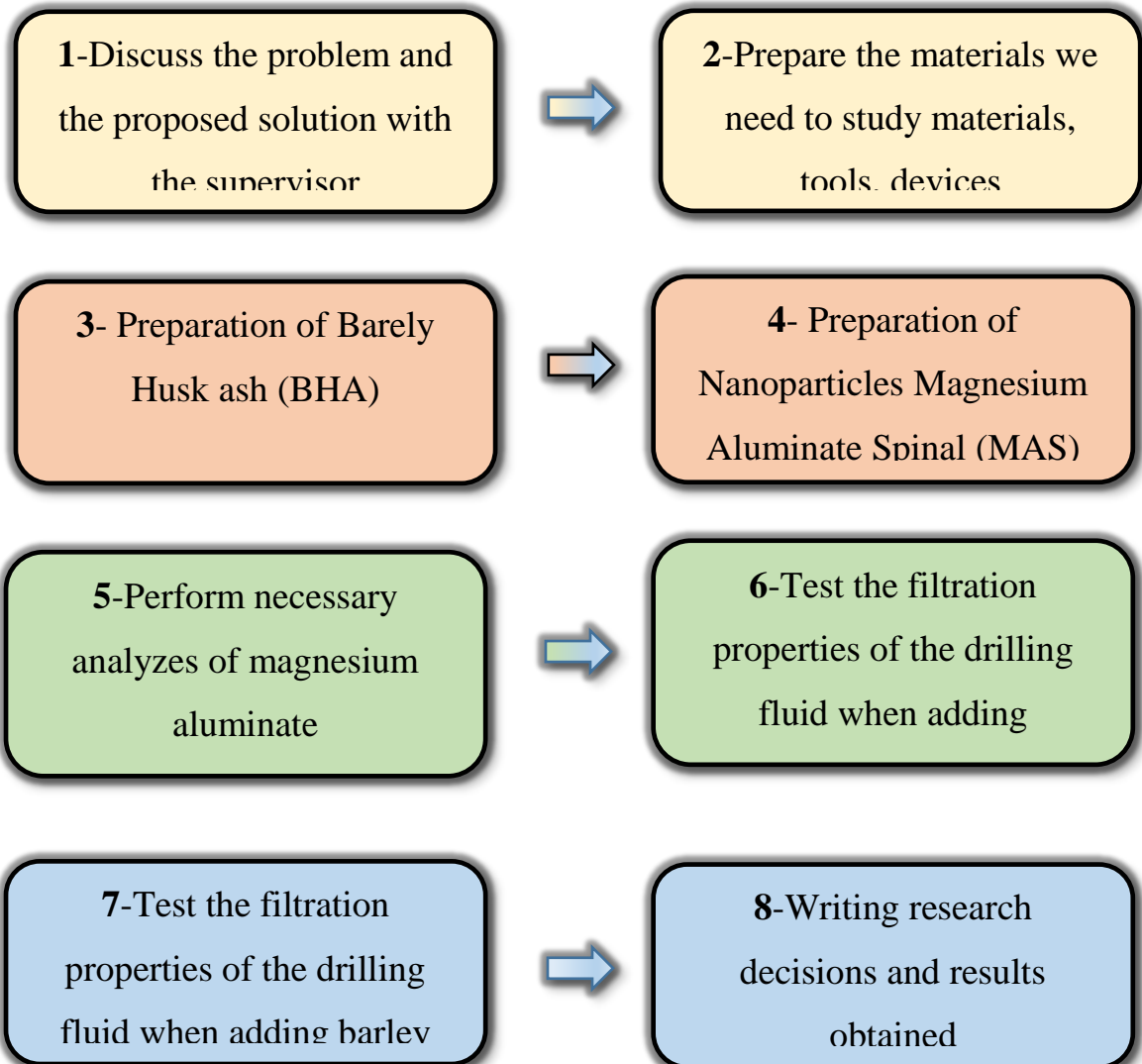

Chapter 4 : Preparation of Barley Husk Ash

"The Theoretical Side"

4.1 Introduction

Barley is one of the ten most common crops in the world, developing countries accounts for about 18% (26 million tons) of total barley production in world [28], barley husk is an agricultural byproduct whose direct utilization as a carbohydrate source. Barley is recognized as one of the most economic and important cereals in the world, structure of barley husk and related plants was studied since 1940 by many investigators using physical chemical techniques[29, 30]

the constituents of barley husk are both organic and inorganic compounds. analysis reported show that the organic matter present in husks is generally, protein, fat, carbohydrates and crude fiber, very small amounts of other compounds are also reported such as organic acids, the inorganic constituents have generally been determined in the ash which comprise about 6-34% of the husk.[31]

By burning barley bran barley ash is obtained, BHA It is a substance that contains high amounts of silicon dioxide [32], Very light ash is easily carried by wind and water in dry condition [33], Among the family of other agro-wastes, and the ash generated usually creates disposal problems. The chemical process discussed not only provides a solution for waste disposal but also recovers a valuable silica product, together with certain useful associate recoveries[34].

It will help to solve problems otherwise encountered in disposing of the wastes. Disposal of the husks is a big problem, and open heap burning is not acceptable on environmental grounds, and so the majority of husk is currently going into

landfill , This has led to the benefit of these husks and their use as a solution to several problems and used in several industries, including cement[35].

We also found that it has many advantages including low permeability and for this reason was used in test the drilling fluid during this project.

The purpose of this chapter is to prepare a quantity of barley husks ash for use in the filtration test for drilling fluids.

4.2 Chemical Composition of BHA.

Of the most prominent and important elements in the barley husks ash is :

Table 2 : Some Compounds Formula of BHA

Compound Formula	Concentration (%) of BHA
MgO	2.125
Al ₂ O ₃	8.775
SiO ₂	79.298
K ₂ O	4.303
CaO	2.305

"Practical side"

4.3 Preparation of Barley Husks Ash (BHA).

1. Washes barley husk separately by passing running water on them for a few times and then washed with distilled water.
2. Drying barley husk in a sunny place.



Fig 6: Drying of Barley Husk in Sunny Place.

3. Roasting barley husk on coal in the air.



Fig 7: Roasting of Barley Husk.

5.4.4. Burn barley husk at 900 C for 8 h.



Fig 8 : Burning Furnace

5.4.5. Screening through standard sieve 0.125 mm.[15]



Fig 9: Screening of Barley Husk ash

Chapter 5: Preparation Nanoparticles " Magnesium aluminate Spinel" (MAS)

"The Theoretical Side"

5.1 Introduction

Nanotechnology is a technology capable of achieving high degrees of accuracy in the functions, sizes and shapes of materials and their components. This has led to the use of nanotechnology at the present time and has a great future in medicine, petrochemical and chemical industries, drugs, electronics ,etc.

Nanotechnology is based on the principles of physics, chemistry, electrical engineering, chemical engineering ,etc.

This technology has emerged because of human leapfrogging and scientific breakthroughs that have radically changed most aspects of human life.[36]

The concept of nanotechnology is based on the design of particles of matter at a scale of 1 to 100 nanometers to give new properties and behaviors to the material , The behavior of the material depends on its size, and this enables us to control the engineering of its properties. Based on this concept, the effects of a great technique, encompassing a wide range of technical fields.[37]

In this chapter of this project Nanoparticles " Nanomagnesium aluminate spinal" (chemically, bottom-up) was prepared and studied geometrically.

The purpose of the preparation is for use in the field of oil, so as to test to solve the problem of loss of drilling fluids through the layers of the earth during the drilling process , Refer to the selection of this material for reasons Previously the mentioned.

5.2 Magnesium aluminate Spinel (MAS)

Magnesium aluminate (MgAl_2O_4) spinel (MAS) is a synthetic material with cubic crystal structure and excellent chemical, thermal, dielectric, mechanical and optical properties. These properties made MAS an indispensable material in industrial technology .

Recently, magnesium aluminate (MgAl_2O_4) spinel (MAS) has received a great deal of attention from the industry on account of its best combination of several important properties [38].

5.3 Physical and Chemical Properties of Magnesium Aluminate Spinel(MAS).

Some important characteristics of magnesium aluminate spinel are :

Table 3 : Characteristics of MAS[38]

Property	value
Molecular Weight(g/mol)	142.27
Density(g cm^{-3})	3.58
Hardness(Gpa)	16
Melting Point($^{\circ}\text{C}$)	2135
The color	White
Chemical Reaction	Chemically inert
conductivity	Isolated Material

5.4 Applications of Magnesium Aluminate Spinal (MAS)

1. Optical engineering applications.
2. Neutron radiation resistance applications.
3. Humidity sensor applications.
4. Refractory applications .
5. Catalyst and catalyst support applications .[39]

5.5 Methods of Preparing Nanoparticles "Magnesium Aluminate Spinel" (MAS)

1. Coprecipitation method .[40]
2. Wet-chemical process .[41]
3. Template method .[42]
4. Sol–gel technique .[43]
5. Silica xerogel template method .[44]
6. Self-generated organic template method .[45]

Although several routes exist for the preparation of fine magnesium aluminate powder, consideration of affordability and versatility of a route still remain as a major challenge for the materials scientists involve in the development of new synthetic routes. In this chapter, we have investigated nanosized powders of $MgAl_2O_4$ by a modified sol–gel Method which results in high-specific surface area under high- temperature calcination , The route used is technically simple, affordable, and versatile compared to the other existing chemical routes.

5.6 Analytical Instruments.

There are many devices for the analysis and diagnosis of materials to know all their physical and chemical properties composition and others.

In this project, we only need to know which instruments were used for the analysis and diagnosis of Magnesium Aluminate spinel (MAS) and are :

1. Infrared instrument.

The device assures functional groups that are in the product , so that studying the active groups that are in the sample .

2. X-ray diffraction instrument.

It is a device that studies the crystal structure of the sample .

5.7 Potential impurities that appearing With Magnesium aluminate Spinel.

Some preparations for magnesium aluminate spinel show in the results of its analysis some impurities such as:

1. Sodium Oxide (Na_2O).
2. Calcium Oxide (CaO).
3. Silica dioxide (SiO_2).
4. Ferric Oxide (Fe_2O_3).[46]

Where the percentage of impurities of Magnesium Aluminate Spinel varies from product to other, and impurities sometimes appear during filtration stage [46], These impurities may be due to absorption of CO_2 and moisture from the air during the drying phase [46], and other causes that may create impurities with the product, These impurities can give advantages and improvements in the material and can reduce the quality of the product and its properties.

"Practical side"

5.8 Laboratory Safety Instructions and Recommendations.

The work of the laboratories requires dealing with the equipment and equipment and various tools required to perform various scientific activities, which may be a serious risk, especially when the lack of care and caution and lack of skills to deal with and because laboratory work is a basic support for the study of science and other applied materials, safety instructions and procedures are an important and effective aspect of their learning, which calls for the need to work towards the achievement of laboratory security.

So before you take any step inside the lab you should read the safety instructions and recommendations written at the end of the project.

5.9 Sol-gel Method.

pure magnesium aluminate spinel was prepared via sol-gel technique .

the sol-gel process , is a versatile solution process for making ceramic and glass material . in general , the sol-gel process involves the transition of a system from a liquid " sol" into a solid " gel" phase , the starting materials used in the preparation of the "sol" are usually inorganic metal salts or metal organic compounds , in a typical sol-gel process , the precursor is subjected to a series of hydrolysis and polymeration reactions to form a colloidal suspension , or a " sol" , when the " sol" is cast into a mold , a wet " gel" will form . with further drying and heat-treatment , the " gel " , sol-gel derived materials have diverse applications in optics , electronics , energy, bio-sensors , medicine technology.

5.10 Materials.

The starting material used in this Experimental is :

1. Aluminum hydroxide $\text{Al}(\text{OH})_3 \cdot \text{XH}_2\text{O}$.
2. Magnesium chloride hexa hydrate $\text{MgCl}_2 \cdot 6 \text{H}_2\text{O}$.

5.11 Calculations To Prepare 30 g of MgAl_2O_4 .

Wt. of $\text{Mg Al}_2 \text{O}_4 = 142.2656 \text{ g/mol}$.

$$\text{Mol} = \frac{30}{142.2656} = 0.2109 \text{ mol}$$

Wt of $\text{Al(OH)}_3 \cdot \text{XH}_2\text{O} = 78.00 \text{ g/mol}$.

Grams of $\text{Al(OH)}_3 \cdot \text{XH}_2\text{O} = 78 \cdot 2 \cdot 0.2109 = 32.9004 \text{ g}$.

Wt of $\text{Mg Cl}_2 = 203.30 \text{ g/mol}$.

Grams of $\text{Mg Cl}_2 = 203.30 \cdot 1 \cdot 0.2109 = 42.8759 \text{ g}$.

5.12 Tools experiment.

1. Cups (2000ml , 100 ml).
2. Distilled water.
3. heater.
4. Suppression of separation.
5. pregnant.
6. magnet.
7. Buchner funnel.
8. Filtration papers.
9. Burning Furnace.

5.13 Steps of the experiment.

1. The weight of the reaction material is to prepare 30 g of $\text{Mg Al}_2 \text{O}_4$



Fig 10: Weight of $\text{Al(OH)}_3 \cdot \text{XH}_2\text{O}$.



Fig 11 : Weight of $\text{MgCl}_2 \cdot 6 \text{H}_2\text{O}$.

2. Equi-molecular proportions of magnesium chloride hexa hydrate $\text{MgCl}_2 \cdot 6 \text{H}_2\text{O}$ and aluminum hydroxide $\text{Al}(\text{OH})_3 \cdot \text{XH}_2\text{O}$ were prepared through suspending the starting materials separately in distilled water , Where it was suspended $\text{Al}(\text{OH})_3 \cdot \text{XH}_2\text{O}$ in 1600ml of distilled water at 79°C and $\text{MgCl}_2 \cdot 6 \text{H}_2\text{O}$ in 20 ml of distilled water at 25°C , then aluminium hydroxide solution was added step wisely from a separating funnel to magnesium chloride solution with continuous stirring with a metallic magnet .

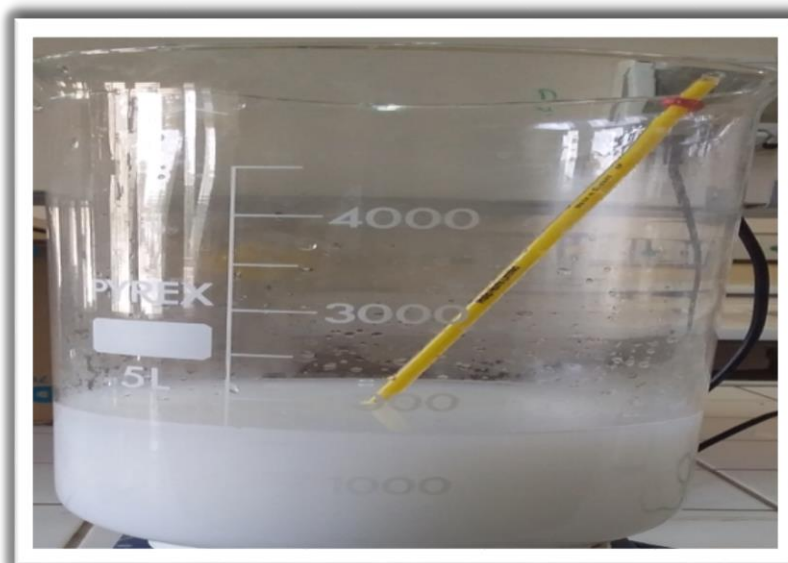

Fig 12 : Suspense of $\text{Al}(\text{OH})_3 \cdot \text{XH}_2\text{O}$



Fig 13 : Suspende Of $MgCl_2 \cdot 6 H_2O$

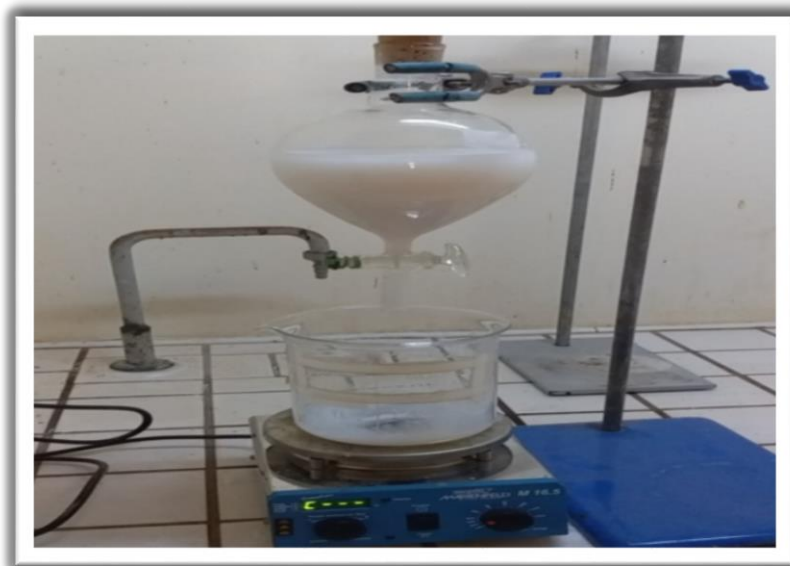

Fig 14 : Addition Aluminum Hydroxide Solution From A Separating Funnel To Magnesium Chloride Solution.

3. After completion of the additive, the solution is filtered and the filter material is dried at 25 C° for 24h .



Fig 15 : Filtration By Buchner Funnel.



Fig 16 : Drying of Mg Al₂ O₄.

4. Burn the dry material in the burner oven at 900 for 1 hour.



Fig 17 : Burning Furnace

5. The sample was investigate through their solid-phase composition using X-ray diffraction technique (XRD).

5.14 Analysis and Results

1. FT-IR analysis.

1.1 FT-IR analysis of reaction materials.

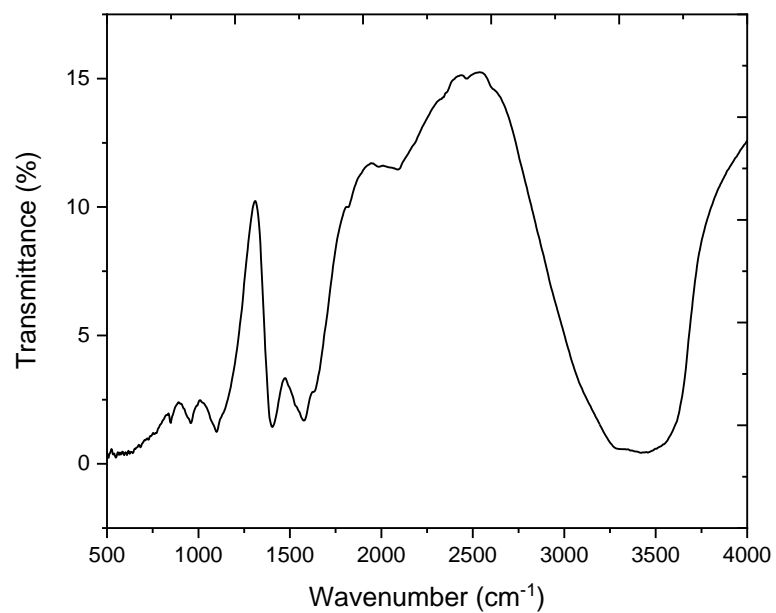

Fig18: FT-IR spectra of $\text{Al(OH)}_2 \cdot \text{XH}_2\text{O}$

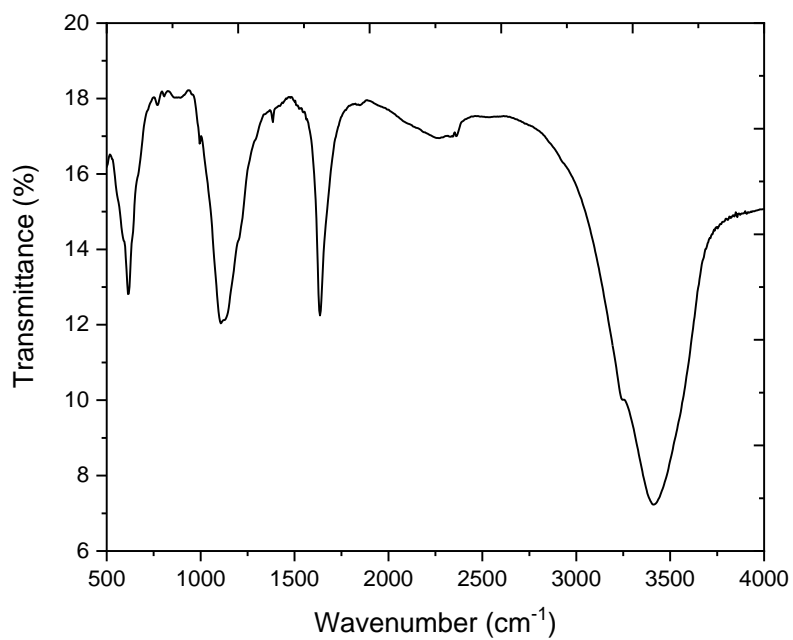

Fig19: FT-IR spectra of $\text{MgCl}_2 \cdot 6\text{H}_2\text{O}$

1.2 FT-IR analysis of Production Material.

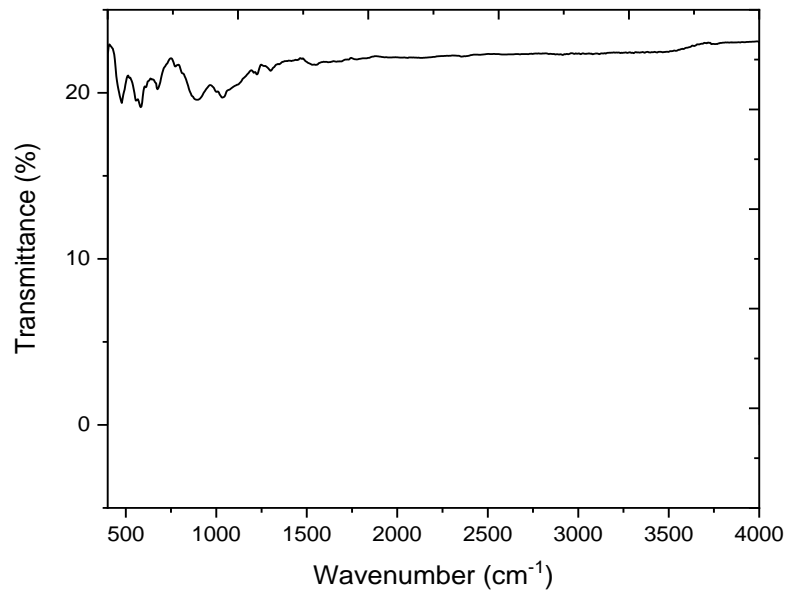

Fig 20: FT-IR spectra of Mg Al₂ O₄

2. XRD analysis.

2.1 Graphic & Phase identification of The Sample.

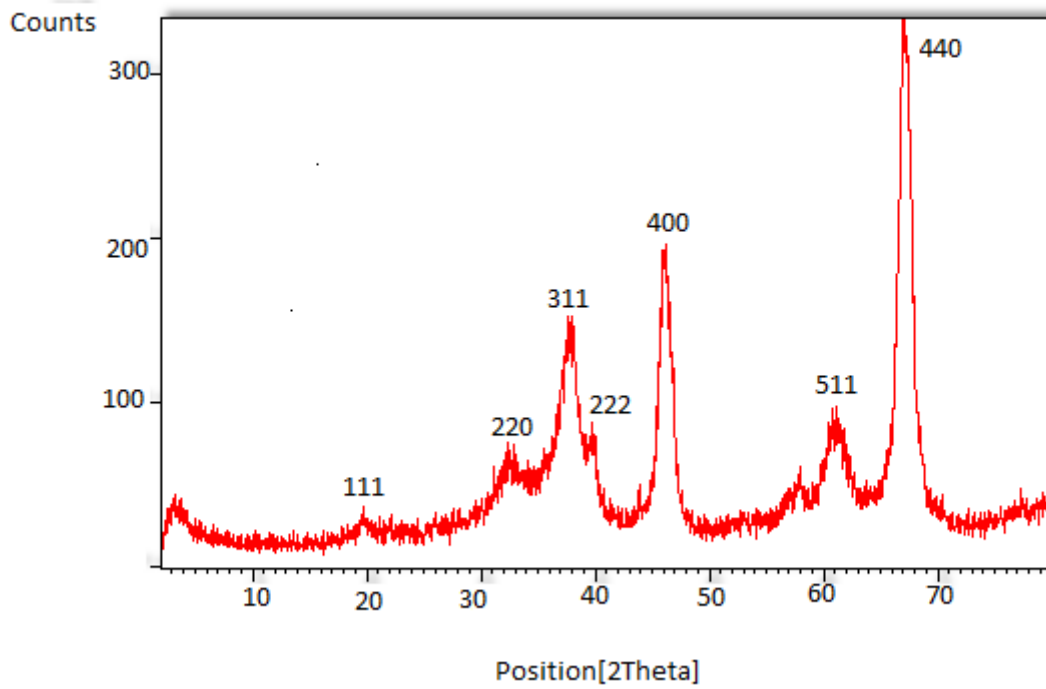

Fig 21 : XRD analysis of Mg Al₂ O₄.

2.2 Peak List:

Table 4 : Results of XRD Analysis into Mg Al₂ O₄

Pos. [°2Th.]	Height [cts]	FWHM [°2Th.]	d-spacing [Å]	Rel. Int. [%]
2.0492	9.00	0.0590	43.11295	3.33
2.3254	19.23	0.4723	37.99238	7.12
19.7725	7.00	0.9446	4.49022	2.59
20.0300	4.00	0.0900	4.43307	1.48
32.6066	18.00	0.2319	2.74626	6.67
37.8700	101.00	0.3972	2.37580	37.41
39.9130	32.00	0.5510	2.25878	11.85
45.9717	162.00	0.5510	1.97421	60.00
60.9700	29.00	0.4226	1.51965	10.74
66.8923	270.00	0.4800	1.39761	100.00

5.15 Calculations.

1. Crystalline Size D

Crystalline Size D Using the Debye-Scherrer equation :

$$D = \frac{0.89 \lambda}{\beta \cos \theta}$$

λ : The Wave Length of Radiation (1.54186 Å).

β : is the full width at half maximum (FWHM).

θ : is the Scattering angle(rad°).

Table 5 : Calculation For Find Crystalline Size D

$\beta(\text{rad}^\circ)$	angle θ	D(nm)
0.00102947	1.0246	134.78064
0.00824319	1.1627	16.83765
0.01648638	9.88625	8.543966
0.00157079	10.015	89.70903
0.00404742	16.3033	35.72181
0.00693245	18.935	21.16223
0.00961676	19.9565	15.35157
0.00961676	22.98585	15.67425
0.00737576	30.485	21.83198
0.00837758	33.44615	19.85145

Average of Crystalline size (D = 37.94646 nm).

2. Lattice constant (a)

Lattice constant $a = b = c$.

$$a = d_{hkl} (h^2 + k^2 + L^2)^{1/2}$$

Table 6 : Calculation For Find Length Of Cubic

d-spacing	Millar index	a (nm)
4.49022	111	7.77729
2.74626	220	7.76760
2.37580	311	7.87964
2.25878	222	7.82464
1.97421	400	7.89684
1.51965	511	7.89633
1.39761	440	7.90608

Average of Length of the cube side ($a = 7.84978 \text{ \AA}$).

3. Unit cell Volume (V_{cell}).

$$V_{\text{cell}} = 483.69477 \text{ \AA}^3.$$

4. The X-ray density (ρ_{XRD})

$$\rho_{\text{XRD}} = (\text{FW} * Z * 1.66) / V_{\text{cell}}$$

FW : Molecular weight of $\text{Mg Al}_2 \text{O}_4$.

Z : Number of units for cube.

$$\rho_{\text{XRD}} = 3.9059 \text{ g/cm}^3 .$$

5. The specific surface area (S_{XRD})

$$S_{\text{XRD}} = 6000 / (D \rho_{\text{XRD}}).$$

$$S_{\text{XRD}} = 40.48078 \text{ m}^2 / \text{g}.$$

Chapter 6 : Filtration Test .

6.1 Introduction

Filtration control has a considerable impact on drilling fluid properties & performance, on drilling costs and on well productivity. The requirements for filtration control, with regard to optimisation of the various stages of drilling a well.

Fluid loss, a key parameter in drilling fluid design Fluid loss (control) has an effect on a number of drilling and completion parameters. It is known to have a major effect on cake properties, penetration rate and costs.[47]

Research into the effects of fluid loss from drilling fluids (DF) was initiated in 1994. Initially the investigation was aimed at studying the relationship between fluid loss and impairment. It was soon realised that there were good arguments to extend the investigation to the wider field of the effect(s) of fluid loss on a number of drilling The decision was taken to design and build multifunctional experimental equipment that could be used to study a number of fluid loss related aspects of DF design[47] , In this research, the filter press equipment was used to determine the filtration properties and the filter cake on the walls of the hole, by means of a measure of the relative quantity of the filtration loss of the permeable formations and the thickness of the filter cake .[16]

6.2 Filtration.

Filtration refers to the process of separating the liquid phase of a drilling fluid from the solid phase by passing the fluid through a permeable medium, if the pores in the permeable medium are small enough, it will permit the passage of the liquid, but restrict the passage of the solids particles. These particles, which consist of formation solids as well as commercial clays and weighting materials, will build up and form a cake on the surface of the filtering medium.

The liquid phase which passes through the medium is called the filtrate and contains soluble ions such as salts, calcium, and soluble chemicals.[16]

6.3 Types of Filtration.

1. Static Filtration.
2. Dynamic Filtration.[16]

6.4 Installing of Filter Press.

Filtration device parts has been gathered and installed such as shown in (figure.22) below and these parts are:

1. Top Cop.
2. Rubber.
3. Cell.
4. Filter Paper.
5. Screen.
6. Base Cop with Filtrate Tube.
7. Filtrate Tube.

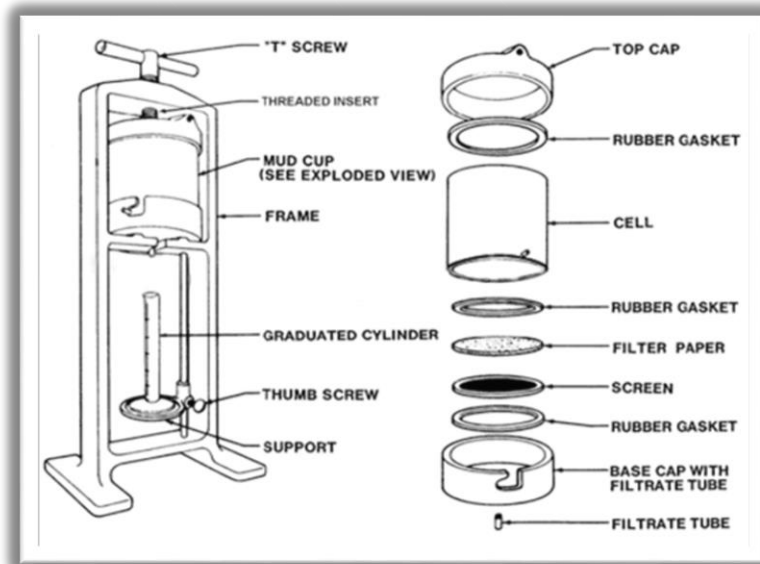

Fig22 : Standard API Filter Press[48]

"Practical side"

6.5 Laboratory Safety Instructions and Recommendations.

The work of the laboratories requires dealing with the equipment and equipment and various tools required to perform various scientific activities, which may be a serious risk, especially when the lack of care and caution and lack of skills to deal with and because laboratory work is a basic support for the study of science and other applied materials, safety instructions and procedures are an important and effective aspect of their learning, which calls for the need to work towards the achievement of laboratory security.

So before you take any step inside the lab you should read the safety instructions and recommendations written at the end of the project.

6.6 Preparation of drilling fluids.

In this research, the water-based drilling fluid was prepared according to the standard API specifications. The components of the drilling fluid were mixed by Hamilton batch mixer and cup for 10 minutes at room temperature. The drilling fluid settles for 24 hours after mixing, before used for testing experiments. The components of the drilling fluid for each experiment are:

1. Experiment 1:

1.1 Distilled water (350 ml).

1.2 Bentonite (22.5 g).

2. Experiment 2:

2.1 Distilled water (350 ml).

2.2 Bentonite (22.5 g).

2.3 Nanocarboxymethyl Cellulose CMC (3g - 5g - 7g).

3. Experiment 3:

3.1 Distilled water (350 ml).

3.2 Bentonite (22.5 g).

3.3 Magnesium aluminate Spinal MAS (3g - 5g - 7g).

4 Experiment 4:

4.1 Distilled water (350 ml).

4.2 Bentonite (22.5 g).

4.3 Barley husks ash BHA (3g – 5g – 7g).

The drilling fluid samples were used to test the loss of drilling fluids and measure the thickness of the clay cake to determine whether the material was considered a good material to reduce water loss (mud filtration) and compare results with each other, These samples were also used to conduct additional tests to determine some of the characteristics of the drilling fluid (density, viscosity, pH) for these samples.

6.7 Test Procedures.

- 1.** Detach the mud cell from filter press frame.
- 2.** Remove bottom of filter cell, place right size filter paper in the bottom of the cell.
- 3.** Introduce mud to be tested into cup assembly, putting filter paper and screen on top of mud tighten screw clamp.
- 4.** With the air pressure valve closed, clamp the mud cup assembly to the frame while holding the filtrate outlet end finger tight.
- 5.** Place a graduated cylinder underneath to collect filtrate.
- 6.** Open air pressure valve and start timing at the same time.
- 7.** Report cc of filtrate collected for specified intervals up to 30 minutes.
- 8.** Tabulate the results in an appropriate table.

6.8 Results and Calculations.

1. Results and calculations of filtration tests at addition 3g of materials (Fresh – CMC – BHA – MAS) into drilling fluid.

Table 7: Results of Filtration Test For Mud+3g For Different Materials.

Time	Volume of Fresh Mud (cm ³)	Volume of Fresh Mud + 3g CMC (cm ³)	Volume of Fresh Mud +3g BHA (cm ³)	Volume of Fresh Mud + 3g MAS (cm ³)
0 min	2.2	2	2	3.6
5 min	7.4	3	5.9	10.4
7.5 min	9.4	3.9	7.2	12.4
10min	10.6	4.4	8.4	14.8
15min	13.2	5.2	10.8	18.8
20min	16.1	5.9	12.2	21.2
25min	18.8	6.9	14	24.2
30min	21	7.9	15.8	27.2
Mud Thickness	0.128 in	0.058 in	0.172 in	0.402 in
PH	9.5	10	10	10

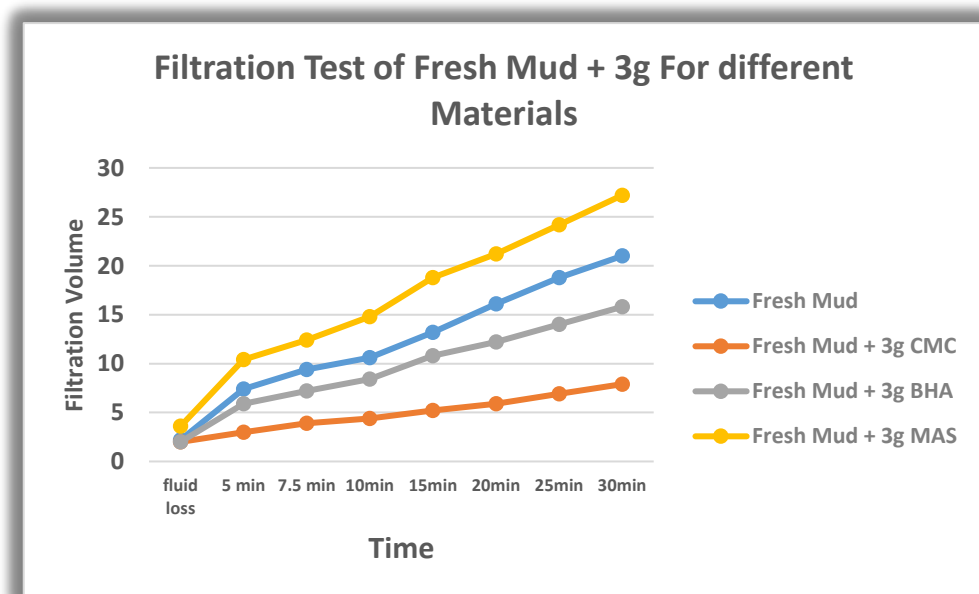

Fig 23 : Filtration Test of Fresh Mud + 3g for Different Materials

2. Results and calculations of filtration tests at addition 5g of materials
(Fresh – CMC – BHA – MAS) into drilling fluid.

Table 8 : Results of Filtration Test For Mud+5g For Different Materials

Time	Volume of Fresh Mud (cm ³)	Volume of Fresh Mud +5g CMC (cm ³)	Volume of Fresh mud +5g BHA (cm ³)	Volume of Fresh mud +5g MAS (cm ³)
0 min	2.2	2	2	3
5 min	7.4	2.6	6.2	10.2
7.5 min	9.4	2.7	7.8	12
10min	10.6	3.9	8.8	14
15min	13.2	4.8	11	17.2
20min	16.1	5.4	12.9	19.8
25min	18.8	6	14.8	22.2
30min	21	7	16	24.6
mud Thickness	0.128 in	0.024 in	0.123 in	0.143 in
PH	9.5	10	10	10

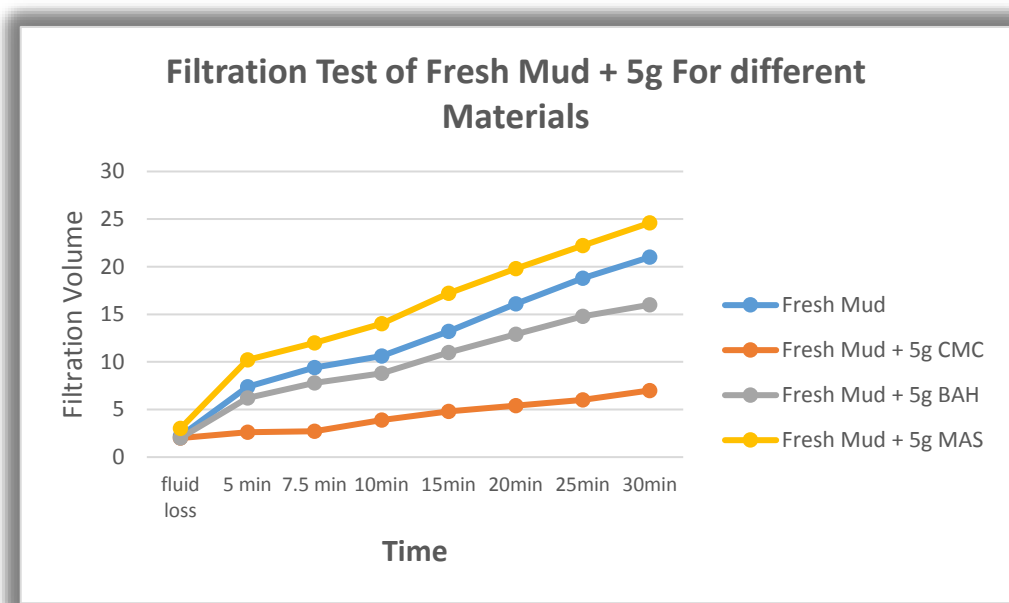

Fig 24 : Filtration Test of Fresh Mud + 5g for Different Materials

3. Results and calculations of filtration tests at addition 7g of materials (fresh – CMC – BHA – MAS) into drilling fluid.

Table 9 : Results of Filtration Test For Mud+7g For Different Materials

Time	Volume of Fresh Mud (cm³)	Volume of Fresh Mud +7g CMC (cm³)	Volume of Fresh Mud + 7g BHA (cm³)	Volume of Fresh Mud + 7g MAS (cm³)
0 min	2.2	2.2	2.2	3
5 min	7.4	2.4	7.4	11.9
7.5 min	9.4	2.8	9	14
10min	10.6	3.4	10.4	15.8
15min	13.2	4.2	12.6	19
20min	16.1	4.9	14.5	21.6
25min	18.8	5.1	16.2	24.2
30min	21	5.9	17.5	26.8
mud Thickness	0.128 in	0.146 in	0.094 in	0.344 in
PH	9.5	10	10	10

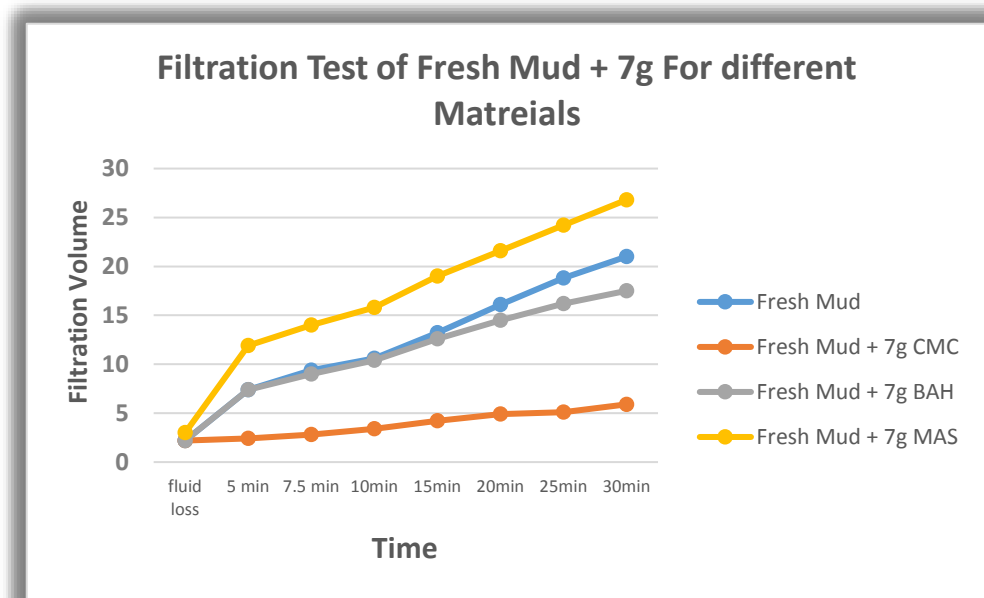

Fig 25 : Filtration Test of Fresh Mud + 7g For Different Materials

6.10 Additional Tests Procedures.

1. Mud density test Procedures.

The density test of the drilling fluid is performed by the mass balance equipment.

1.1 Calibration.

1. Remove the lid from the cup, and completely fill the cup with water.
2. Replace the lid and wipe dry.
3. Replace the balance arm on the base with knife-edge resting on the fulcrum.
4. The level vial should be centered when the rider is set on 8.33. If not , add to or remove shot from the well in the end of the beam.

1.2 Test Procedure.

1. Remove the lid from the cup, and completely fill the cup with the mud to be tested.
2. Replace the lid and rotate until firmly seated, making sure some mud is expelled through the hole in the cup.
3. Wash or wipe the mud from the outside of the cup.
4. Place the balance arm on the base, with the knife-edge resting on the fulcrum.
5. Move the rider until the graduated arm is level, as indicated by the level vial on the beam.
6. At the left-hand edge of the rider, read the density on either side of the lever in all desired units without disturbing the rider.
7. Note down mud temperature corresponding to density.

1.3 Result and calculations.

1. Results and calculations of density tests at addition 3g of materials (fresh – CMC – BHA – MAS) into drilling fluid.

Table10: Results of Density Test of Fresh Mud +3g for Different Materials

	Fresh Mud	Fresh Mud +3g CMC	Fresh Mud +3g BHA	Fresh Mud +3g MAS
Density Mud	8.5 ppg	8.75 ppg	8.78 ppg	8.75 ppg
Sp.gr	1.02gm/cm ³	1.05 gm/cm ³	1.043gm/cm ³	1.05 gm/cm ³

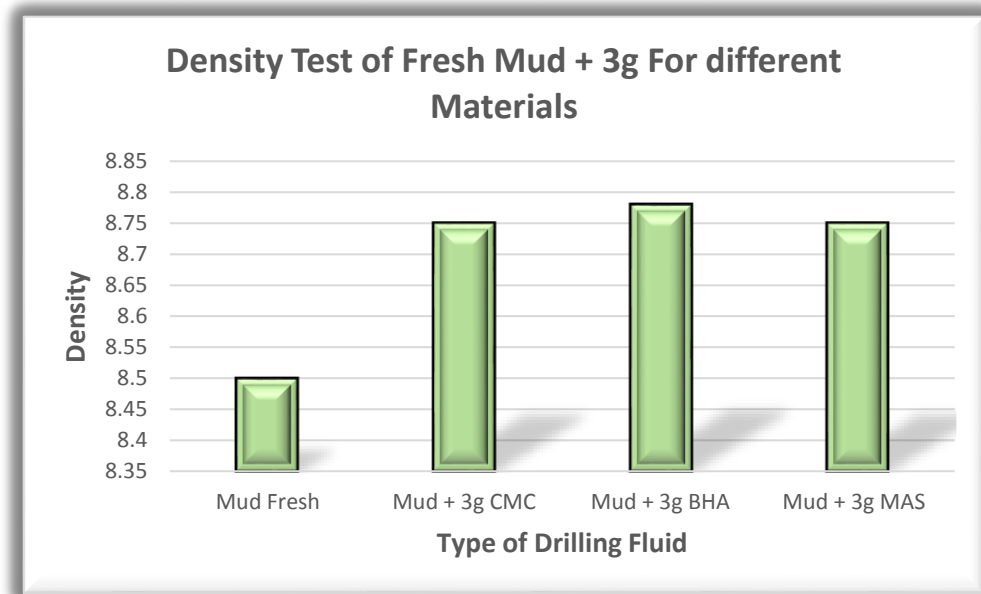

Fig 26 : Density Test of Fresh Mud + 3g for Different Materials.

2. Results and calculations of density tests at addition 5g of materials (fresh – CMC – BHA – MAS) into drilling fluid.

Table11: Results of Density Test of Fresh Mud +5g for Different Materials.

	Fresh Mud	Fresh Mud +5g CMC	Fresh Mud +5g BHA	Fresh Mud +5g MAS
Density Mud	8.5 ppg	8.65 ppg	8.75 ppg	8.8 ppg
Sp.gr	1.02gm/cm ³	1.038 gm/cm ³	1.045gm/cm ³	1.06 gm/cm ³

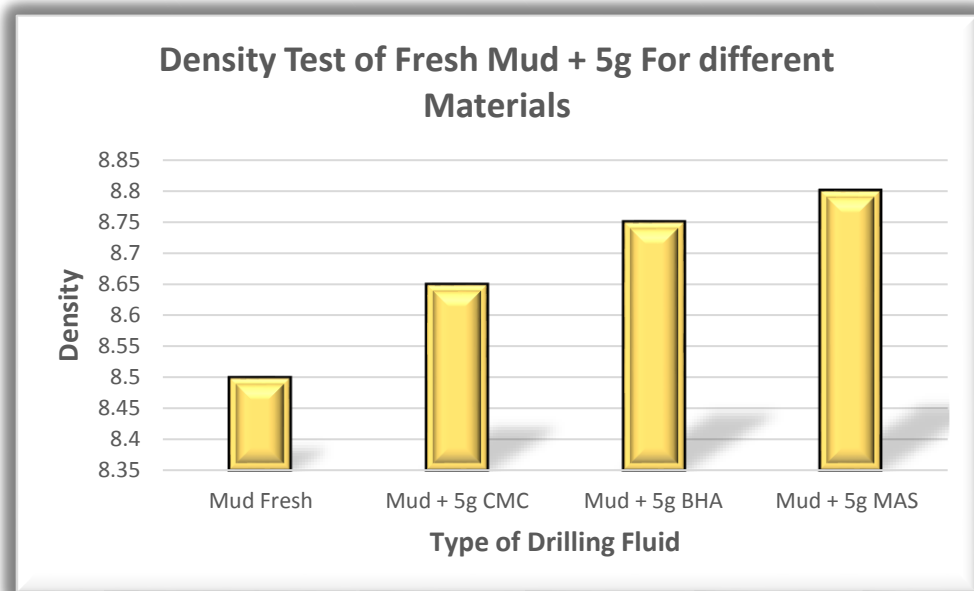

Fig 27 : Density Test of Fresh Mud + 5g for Different Materials.

3. Results and calculations of density tests at addition 7g of materials (fresh – CMC – BHA – MAS) into drilling fluid.

Table12: Results of Density Test of Fresh Mud +7g for Different Materials.

	Fresh Mud	Fresh Mud +7g CMC	Fresh Mud +7g BHA	Fresh Mud +7g MAS
Density Mud	8.5 ppg	8.7 ppg	8.78 ppg	8.8 ppg
Sp.gr	1.02gm/cm ³	1.04 gm/cm ³	1.05gm/cm ³	1.065gm/cm ³

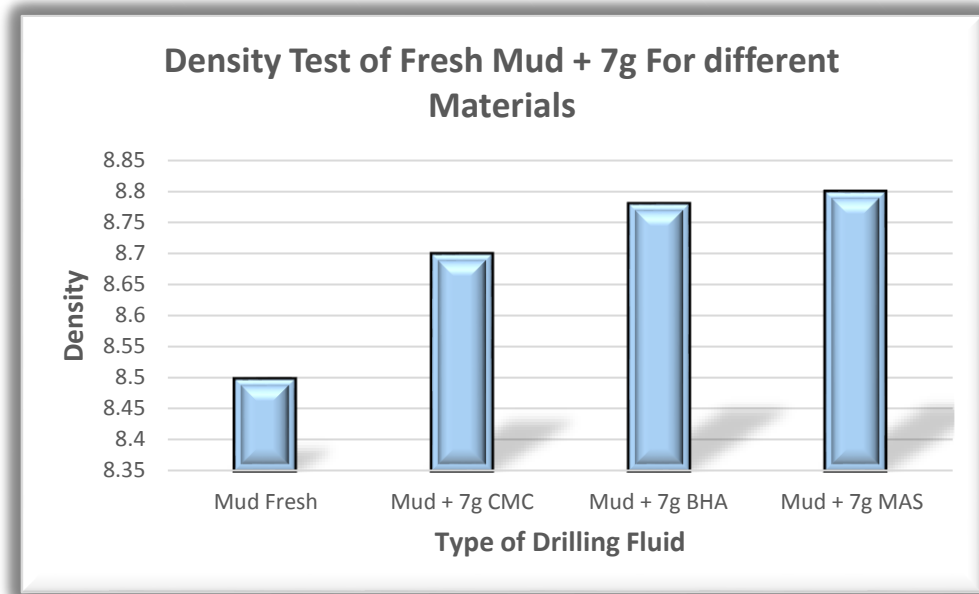

Fig 28 : Density Test of Fresh Mud + 7g for Different Materials.

2. Mud Rheology Test Procedures

2.1 Mud Viscosity Test Procedures

The viscosity of the drilling fluid is tested by the viscometer.

2.1.1 Test Procedure.

1. Place a recently agitated sample in the cup, tilt back the upper housing of the rheometer, locate the cup under the sleeve (the pins on the bottom of the cup fit into the holes in the base plate), and lower the upper housing to its normal position.
2. Turn the knurled knob between the rear support posts to raise or lower the rotor sleeve until it is immersed in the sample to the scribed line.
3. Stir the sample for about 5 seconds at 600 RPM, then select the RPM desired for the best.
4. Wait for the dial reading to stabilize (the time depends on the sample's characteristics).
5. Record the dial reading and RPM.

2.2 Gel Strength Test Procedure.

1. Stir a sample at 600 RPM for about 15 seconds.
2. Turn the RPM knob to the STOP position.
3. Wait the desired rest time (normally 10 seconds or 10 minutes).
4. Switch the RPM knob to the GEL position.
5. Record the maximum deflection of the dial before the Gel breaks, as the Gel strength in lb/100 ft².

2.3 Yield Point Measurement.

To find the yield point , this is calculated by the following equation :

$$YP = 300 \text{ rpm} - \text{Plastic Viscosity.}$$

2.4 Result and Calculations.

1. Results and calculations of rheology tests at addition 3g of materials (Fresh – CMC – BHA – MAS) into drilling fluid.

Table13: Results of Rheology Test of Fresh Mud +3g for Different Materials.

		Fresh Mud	Fresh Mud +3gCMC	Fresh Mud +3g BHA	Fresh Mud +3g MAS
Ø3		9	10	4	13
Ø6		13	11	5	16
Ø100		20	16	7	11
Ø200		24	20	10	17
Ø300		27	25	13	20
Ø600		35	35	20	38
Pv		8	10	7	18
Yp		19	15	6	2
n		0.3743	0.4853	0.6213	0.9257
k		1334.1	618.21	137.64	31.718
gel	10sec	8	11	6	15
string	10min	12	13	11	19

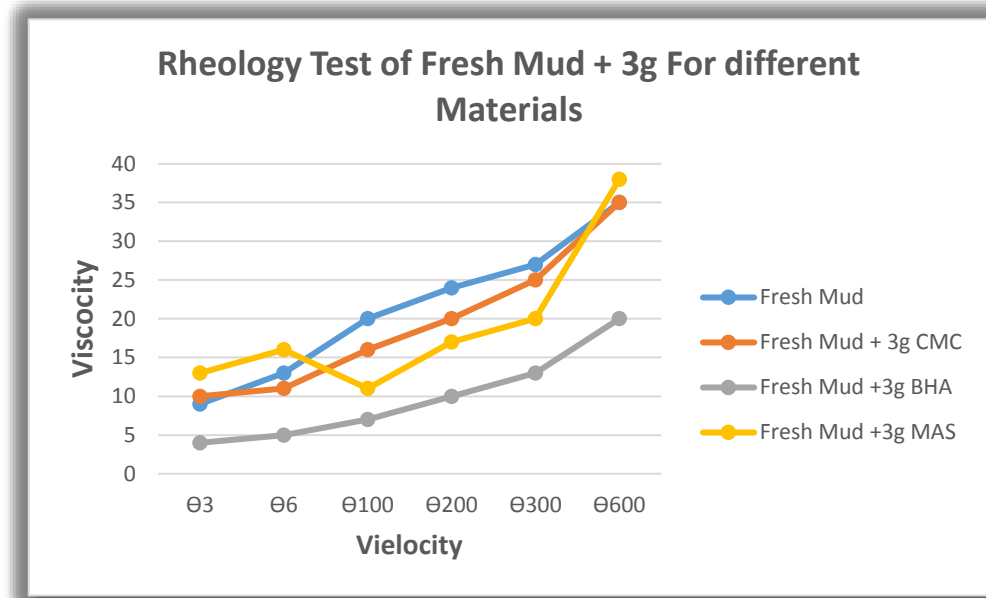

Fig 29 : Rheology Test of Fresh Mud + 3g for Different Materials

2. Results and calculations of rheology tests at addition 5g of materials (fresh – CMC – BHA – MAS) into drilling fluid.

Table14: Results of Rheology Test of Fresh Mud +5g for Different Materials.

		Fresh Mud	Fresh mud +5gCMC	Fresh Mud +5g BHA	Fresh mud +5gm MAS
Ø3		9	12	5	9
Ø6		13	13	7	15
Ø100		20	21	11	20
Ø200		24	24	13	27
Ø300		27	29	16	29
Ø600		35	42	23	43
Pv		8	13	7	14
Yp		19	16	9	15
n		0.3743	0.5342	0.5234	0.5681
k		1334.1	528.65	311.93	427.81
gel	10sec	8	14	8	12
string	10min	12	17	13	21

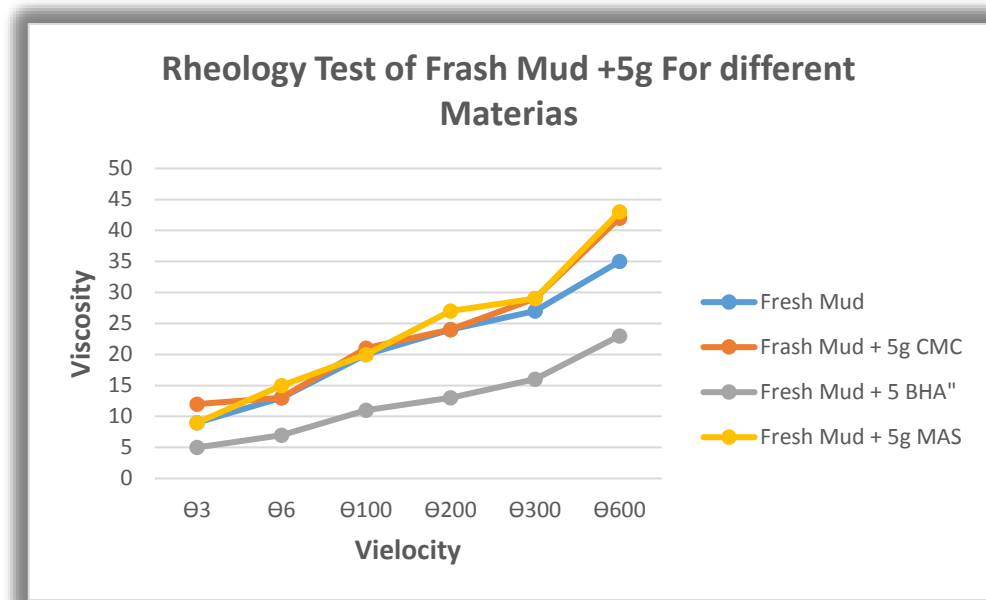

Fig 30 : Rheology Test of Fresh Mud + 5g for Different Materials

3. Results and calculations of rheology tests at addition 7g of materials (Fresh – CMC – BHA – MAS) into drilling fluid.

Table15: Results of Rheology Test of Fresh Mud +7g for Different Materials.

		Fresh Mud	Fresh mud +7g CMC	Fresh mud +7g BHA	Fresh mud +7g MAS
Ø3		9	14	6	12
Ø6		13	17	8	15
Ø100		20	28	12	19
Ø200		24	36	14	22
Ø300		27	46	18	24
Ø600		35	65	25	42
Pv		8	19	7	18
yp		19	27	11	6
n		0.3743	0.4987	0.4738	0.8071
k		1334.1	1046.5	478.19	79.751
gel	10sec	8	16	8	11
string	10min	12	22	13	23

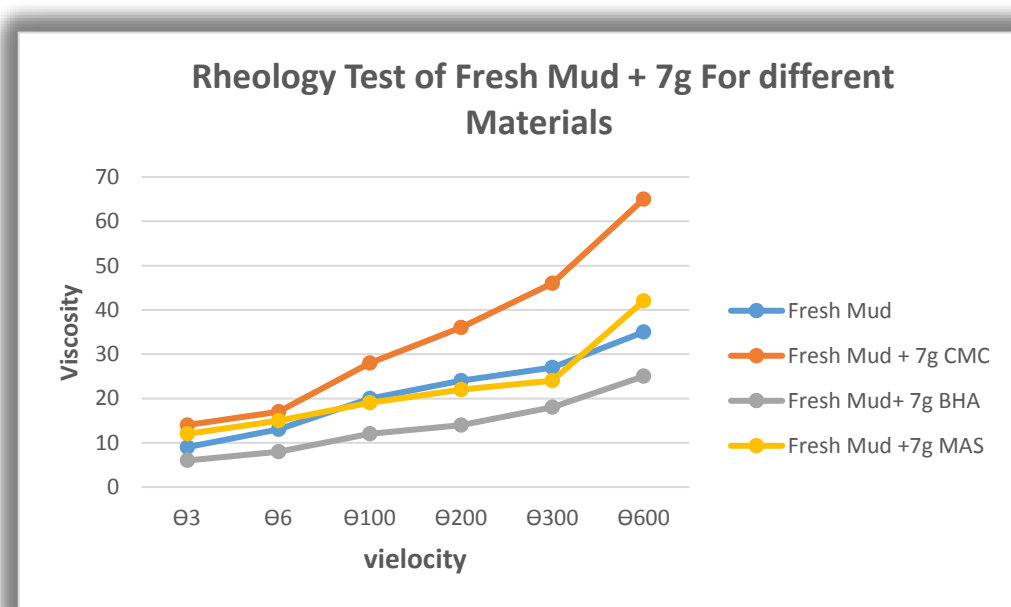

Fig 31 : Rheology Test of Fresh Mud + 7g for Different Materials

Discussion

FT-IR , XRD analysis

(Figure:20) displays the FTIR spectrum of $MgAl_2O_4$ within the range of wavenumber from 400 to 4000 cm^{-1} . As shown, where The observed absorption bands within the wavenumber range of 532-699 cm^{-1} which are associated with lattice vibrations of metal ion and formation of the spinel type structure[49], The observed peaks at approximately 3500 and 1624 cm^{-1} corresponded to -OH stretching and H-O-H banding of adsorbed water , which reflects high surface area of the powder [49, 50]

(Figure:21) shows the X-ray diffraction (XRD) pattern of $MgAl_2O_4$ Which were the observed diffraction peaks were well indexed to the crystalline planes of $MgAl_2O_4$ with a cubic structure.

The XRD data corresponding of miller index (111, 220, 311, 222, 400, 511, 440) was used to estimate the values of the structural parameters of $MgAl_2O_4$ including the crystallite size (D), lattice constant (a), unit cell volume (V_{cell}), the X-ray density (ρ_{XRD}) and the specific surface area (S_{XRD}). The calculated values of D , a , V_{cell} , ρ_{XRD} , S_{XRD} and were found to be 37.94646 nm , 7.8498 Å , 483.69478 Å³, 3.9059 g/cm³, 40.48078 g/m² , respectively , and our results is consistent with several theoretical and empirical results.[51-54].

Filtration Test and addition Test for Drilling Fluid.

The results of the test of the filtration properties at the addition of CMC showed a lower decrease in drilling fluid loss and thickness of mud cake with increasing the added quantity of CMC.

It was also found that when adding 3g of BHA gave better results in loss of drilling fluids and significant reduction in the thickness of mud cake compared

to the results of the experience of loss of drilling fluids when adding MAS in different quantities.

Where the results of the density test of drilling fluid when adding different amounts of CMC , BHA , MAS that there is no significant impact on weight and pH and were very slight changes.

In terms of test results of drilling fluids for gel strength the addition of MAS and CMC in different quantities gave high and distinct results.

The results of the viscosity test were of MAS marked with high results when added in different quantities.

Conclusion

The most important points of evaluation filtration properties of water based drilling fluid by using nanoparticles "magnesium aluminates spinel and " barley husk ash " are :

1. The barley husk ash was prepared in an easy and economical manner and the quantity that was prepared after weight was 15.6124 g.
2. Magnesium aluminates spinel was prepared using Sol-Gel and (FT-IR , XRD) analysis were conducted for this material.
3. Several properties of magnesium aluminates were calculated and their results (the crystallite size ($D = 37.94646$ nm), lattice constant ($a = 7.8498$ Å), unit cell volume ($V_{cell} = 483.69478$ Å³), the X-ray density ($\rho_{XRD} = 3.9059$ g/cm³) and the specific surface area ($S_{XRD} = 40.48078$ g/m²).
4. The results of the filtration test showed that when CMC was added, the lower the loss of fluid and the thickness of the mud cake with an increase of quantity .
5. Where the results of the density test of drilling fluid when adding different amounts of CMC , BHA , MAS that there is no significant impact on weight and pH and were very slight changes.
6. In addition MAS was distinguished by its test of the viscosity properties of the drilling fluid , which gave good results.

Appendixces

1.Laboratory Safety Instructions

Safety in the laboratory must be of vital concern to all those engaged in experimental science work. It is therefore the responsibility of everyone to adhere strictly to the basic safety precautions provided and to avoid any acts of carelessness that can endanger his life and that of others around him. It is equally important to always abide by all the instructions for conducting the experimental work during the laboratory sessions. Below are some guidelines for general laboratory safety and procedures:

1.1 All students must be familiar with the locations and operational procedures of the Emergency Shower, Fire Extinguishers, Gas Masks and Fire Blankets. These safety devices pictured below.

1.2 Laboratory coats, safety glasses and safety shoes **MUST** be worn at all times during the laboratory session. **NO THOABS** and open sandals are allowed during the laboratory sessions.

1.3 Eating, drinking and smoking are strictly **PROHIBITED** in the laboratory at all times. Laboratory glassware should **NEVER** be used for drinking purpose.

1.4 Report any injury immediately for First Aid treatment, no matter how small.

1.5 Report any damage to equipment or instrument and broken glassware to the laboratory instructor as soon as such damage occurs.[48]



Emergency Shower



Fire Blankets



Gas Mask and Fire Extinguisher

2.Recommendations and future studies of Magnesium Aluminate Spinel

2.1 Recommendations.

Recommendations to be considered in future research are:

1. You should be familiar with and know the factors affecting Magnesium Aluminate spinel.
2. The quality and method of storage of reactants in chemical stores should be confirmed in the preparation of Magnesium Aluminate Spinel.
3. You must make sure you Calibration the balance machine before you start weighing the material.
4. Must clean the tool before using it in the preparation of Magnesium aluminate spinel.

1.2 Future studies.

1. Preparation of Magnesium Aluminate Spinel in other ways.
2. Interest in the study of Magnesium Aluminate Spinel industrial (industrial process and technology).

3. Recommendations and future studies to improve filtration properties for drilling fluids.

3.1 Recommendations

Recommendations to be considered in future research are:

1. Conducting a laboratory experiment for this research with a difference in the quantity of additives for the materials and the use of different temperatures, with accuracy in recording data and calculations.
2. Be sure to calibrate the device before testing

3.2 Future studies.

Interest in the study of improving the filtration properties of drilling fluids using low cost nanoparticles.

References

1. Adams, N. and T. Charrier, *Drilling engineering: a complete well planning approach*. 1985: Pennwell Corp.
2. Chilingarian, G.V. and P. Vorabutr, *Drilling and drilling fluids*. 1983.
3. Patel, A.D., *Water-based drilling fluids with high temperature fluid loss control additive*. 1998, Google Patents.
4. Mokhtari, M. and M.E. Ozbayoglu. *Laboratory investigation on gelation behavior of xanthan crosslinked with borate intended to combat lost circulation*. in *SPE Production and Operations Conference and Exhibition*. 2010. Society of Petroleum Engineers.
5. Salih, A., T. Elshehabi, and H. Bilgesu. *Impact of nanomaterials on the rheological and filtration properties of water-based drilling fluids*. in *SPE Eastern Regional Meeting*. 2016. Society of Petroleum Engineers.
6. Garcia-Ochoa, F., et al., *Xanthan gum: production, recovery, and properties*. *Biotechnology advances*, 2000. **18**(7): p. 549-579.
7. Li, M.-C., et al., *Cellulose nanocrystals and polyanionic cellulose as additives in bentonite water-based drilling fluids: Rheological modeling and filtration mechanisms*. *Industrial & Engineering Chemistry Research*, 2015. **55**(1): p. 133-143.
8. Pérez, R., et al., *Non-Newtonian annular vertical flow of sand suspensions in aqueous solutions of guar gum*. *Journal of Petroleum Science and Engineering*, 2004. **44**(3-4): p. 317-331.
9. Singh, S.K., R.M. Ahmed, and F. Growcock. *Vital role of nanopolymers in drilling and stimulations fluid applications*. in *SPE Annual Technical Conference and Exhibition*. 2010. Society of Petroleum Engineers.
10. Tabzar, A., M. Arabloo, and M.H. Ghazanfari, *Rheology, stability and filtration characteristics of Colloidal Gas Aphron fluids: Role of surfactant and polymer type*. *Journal of Natural Gas Science and Engineering*, 2015. **26**: p. 895-906.
11. Wang, W.-J., et al., *Thermo-sensitive polymer nanospheres as a smart plugging agent for shale gas drilling operations*. *Petroleum science*, 2017. **14**(1): p. 116-125.
12. Saboori, R., et al., *Improvement in filtration properties of water-based drilling fluid by nanocarboxymethyl cellulose/polystyrene core-shell nanocomposite*. *Journal of Petroleum Exploration and Production Technology*, 2018. **8**(2): p. 445-454.
13. Leger, J., JM Leger, J. Haines, M. Schmidt, JP Petitet, AS Pereira, and JAH da Jornada, *Nature (London) 383, 401 (1996)*. *Nature (London)*, 1996. **383**: p. 401.
14. Walker Jr, E.H., et al., *The novel low temperature synthesis of nanocrystalline MgAl₂O₄ spinel using "gel" precursors*. *Materials research bulletin*, 2002. **37**(6): p. 1041-1050.
15. Khalil, N., et al., *Beneficiation of the huge waste quantities of barley and rice husks as well as coal fly ashes as additives for Portland cement*. 2014. **20**(5): p. 2998-3008.
16. American Amoco Production Company, *"Drilling Fluids Manual", Section 3*. 2017.
17. Alheina, A.H.A.W., *Drilling Of Oil Well Engineering(Phaseiii)*. 1988.
18. Course, D.E., *Faculty of Energy and mining Engineering at sebha University* 2018.
19. Rabia, H., *Oilwell drilling engineering: principles and practice*. 1985: Graham & Trotman London.
20. Company, A.A.P., *Drilling Fluid Engineering Manual*. Section 3.
21. Bourgoyne, A.T., Millheim, K. K., Chenevert, M. E., & Young, F. S.. *Applied drilling engineering*. (1986).
22. Mohamed omar, k.h., abdasalam hassan *drilling fluids*. sabha university facility of Engineering sciences and technology department of Petroleum Engineering, 2012.
23. Abdulfattah omer yonis , m.m.a., mohamed abdul salam abubaker , mohammed ali mohammed emlawah, *fluid loss* 2015-2016.

24. Ismail Mohammed Idiab , A.S.a.-A., Mursal Hawija Al-Ahmad, *Total smuggling of drilling fluids in the fields of the central region and methods of treatment*. 2015-2016.
25. Al-Ahmad, A.M., *Composition and Characteristics of Drilling Fluids Oil wells*. 1983.
26. Max R. Annis , M.V.S., *Drilling Fluids Technology* July 1974
27. Wacunzo, A., *Drilling Fluid properties* 2012.
28. FAO, *Food and Agriculture organization of the united nations*. 2005.
29. sterling, c., *crystalline silica in plants* .*Am.J . Bot* 54,840. 1967.
30. Kent, M.I., *Technology of cereals (barley)*,. 1983.
31. Lockard:, H.B., *Calorific Value of Fiber-containing Cereal Fractions and Breakfast Cereals*. 1980.
32. P.K. Metha, i.P.o.t.I.S.o.A.i. and C.A. Concrete Technology, Athens, Greece, May 1992, pp. 407–430., .
33. Cook, D., R. Pama, and S. Damer. *Rice husk ash as a pozzolanic material*. in *Proceedings of a Conference on New Horizons in Construction Material (Lehigh University, 1976)*. 1976.
34. Mittal, D.J.R., *Silica from ash*. 1997. **7**: p. 64-66.
35. Chandra, S., *Waste Materials Used in Concrete Manufacturing. Building Materials Science Series*. 1997: Elsevier Science & Technology.
36. saleh, M.m.s., *Nanotechnology and a new scientific era*. 2015.
37. Aarti P. Nikam*, M.P.R., Shilpa P. Chaudhari, *NANOPARTICLES – AN OVERVIEW*. 2014.
38. Ganesh, I.J.I.M.R., *A review on magnesium aluminate (MgAl₂O₄) spinel: synthesis, processing and applications*. 2013. **58**(2): p. 63-112.
39. Ganesh, *A review on magnesium aluminate (MgAl₂O₄) spinel: synthesis, processing and applications*. 2013.
40. Zawrah, M.F., H. Hamaad, and S.J.C.I. Meki, *Synthesis and characterization of nano MgAl₂O₄ spinel by the co-precipitated method*. 2007. **33**(6): p. 969-978.
41. Li, J.-G., et al., *A wet-chemical process yielding reactive magnesium aluminate spinel (MgAl₂O₄) powder*. 2001. **27**(4): p. 481-489.
42. Tripathy, S. and D.J.J.o.A.C.S. Bhattacharya, *Rapid synthesis and characterization of mesoporous nanocrystalline MgAl₂O₄ via flash pyrolysis route*. 2013. **1**(4): p. 328-332.
43. Saberi, A., et al., *A novel approach to synthesis of nanosize MgAl₂O₄ spinel powder through sol–gel citrate technique and subsequent heat treatment*. 2009. **35**(3): p. 933-937.
44. Valdés-Solís, T., G. Marbán, and A.J.C.o.m. Fuertes, *Preparation of nanosized perovskites and spinels through a silica xerogel template route*. 2005. **17**(8): p. 1919-1922.
45. Guan, X., et al., *MgAl₂O₄ nanoparticles: a new low-density additive for accelerating thermal decomposition of ammonium perchlorate*. 2011. **1**(9): p. 1808-1814.
46. Luan, C., et al., *Synthesis and characterization of Co²⁺: MgAl₂O₄ nanocrystal*. 2006. **38**(3): p. 245-249.
47. K. Leerlooijer, S., CAT. Kuijvenhoven, and PA Francis, Shell Research Rijswijk, *Filtration Control , mud design and well productivity*. 1996.
48. KING FAHD UNIVERSITY OF PETROLEUM & MINERALS , D.o.P.E., PETE 203: and D. ENGINEERING, *LABORATORY MANUAL*. APRIL 2003.
49. Waldner, K., et al., *Synthesis of a double alkoxide precursor to spinel (MgAl₂O₄) directly from Al (OH)₃, MgO, and triethanolamine and its pyrolytic transformation to spinel*. 1996. **8**(12): p. 2850-2857.
50. Lee, P., et al., *Synthesis and characterization of nanocrystalline MgAl₂O₄ spinel by polymerized complex method*. 2006. **8**(6): p. 911-917.
51. Hinklin, T. and R.J.C.o.M. Laine, *Synthesis of metastable phases in the magnesium spinel–alumina system*. 2007. **20**(2): p. 553-558.
52. Thibaudeau, P. and F.J.J.o.P.C.M. Gervais, *Ab initio investigation of phonon modes in the MgAl₂O₄ spinel*. 2002. **14**(13): p. 3543.

53. Sreeja, V., et al., *Size dependent coordination behavior and cation distribution in MgAl₂O₄ nanoparticles from ²⁷Al solid state NMR studies*. 2008. **112**(38): p. 14737-14744.
54. Barpanda, P., et al., *Chemically induced order disorder transition in magnesium aluminium spinel*. 2006. **26**(13): p. 2603-2609.

Bibliography

1. Jianjun Guo, Hui Lou, Hong Zhao, Xiaoge Wang, Xiaoming Zheng , Novel synthesis of high surface area MgAl₂O₄ spinel as catalyst support ,2003
2. Ganesh Ibram , A Review on Magnesium Aluminate (MgAl₂O₄) Spinel: Synthesis, Processing and Applications, 2013.